

KPZ - Waagen
German quality construction
INDUSTRIAL QUALITY



200206 00 BR UK €

Mobile weighing | **|** **|** **ATEX Conform**

Of course with valid OIML, class III, KPZ Factory first certification (Option) !!!



Pallet Jack with scale



Pallet Jack with scale
Stainless Steel



KPZ 72 / weighing system for electric stacker,
installed in customer own Truck



KPZ 73S / weighing system for lifting stacker, installed in customer own Truck



KPZ 73B / drum lifter with scale

KPZ 74 / scissorlifts with scale

KPZ 75 / Fork-lift truck scale

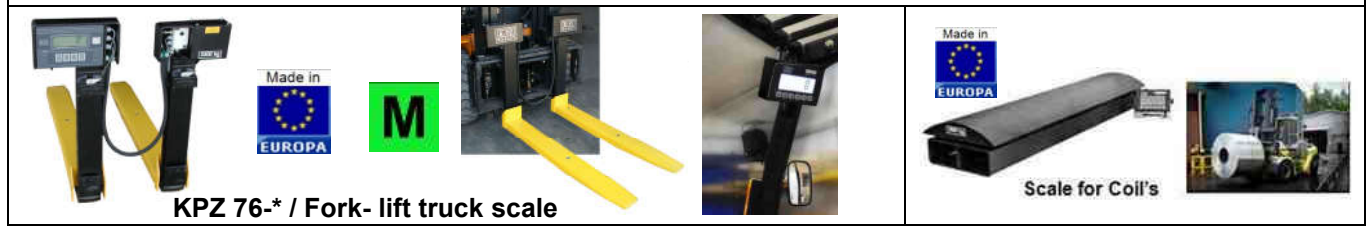

KPZ 76-* / Fork-lift truck scale



Scale for Coil's



KPZ 39-1 KPZ 39-2
Hydraulic Forklift scales

KPZ 601/
barrow scale

KPZ 71-7 | Capacity 2.200 kg | Div. : 100g , 200 g, 500g | accuracy: 0,02 %
German design and own EU production guarantees high quality.

KPZ Hand-cart/barrow scale type: KPZ 601



Compl. with indicator KPZ 51-16.
 Steel powder painted construction
 Capacity 150 kg, division 100 g; incl. battery and adapter.

Calibration protocol as an option. Price on request.



Type	Capacity	Division	Approval	€/pcs	Article-Nr.
KPZ 601	150kg	100g	No	535	601000000150

Options / accessories / extra charge	€/pcs	Article-Nr.
Printers: Options (extra cost) + costs for output RS 232		
Roller printer FAVORIT Plus,	On request	171023000000
serial interface / Setpoints: Options / extra costs		
Serial interface RS 232 C for KPZ 51-16-1		171307000000

Packing dimension	
Type	Packing dimension
KPZ 601	1400x800x500 mm

Special requirements for unique loading - please contact us for more information!

KPZ price includes complete scale with indicator.

. German design and own EU production guarantees high quality.

Special models are our speciality!



KPZ 71-7N / hand pallet truck with integrated scale  
stainless steel DIN 1.4301 / IP67/68+ IP 69K

Capacity 2.200 kg | Division : 100g , 200 g, 500g | accuracy: 0,02 %
the world highest accuracy in mobile scales

EU-approval class M 



weighing capacity up to **2.200 kg**
25 mm LCD – digits
backlight
100 % tare
easy readable



Long exploitation period thanks to lubrication grease nipples

Optionen:



Better quality !!! KPZ applies only EU approved components
Mobile Weighing! = Saved working hours !

German design and own EU production guarantees high quality.

EU-approval class M 

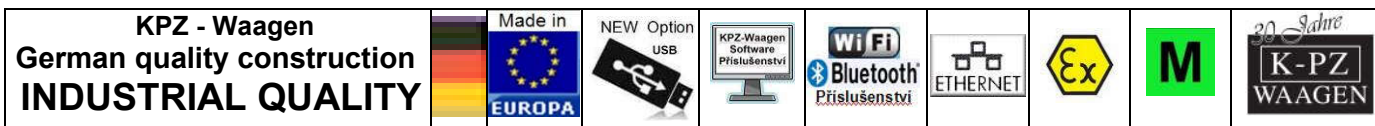

200206 00 BR UK €

Solid and stable platform scales series [KPZ 71-7N](#). **German design and own EU production guarantees high quality.** Designed as floor scales, for food and Chemical industrial weighing. High accuracy. Maintenance-free durable Stainless steel (DIN 1.4301 / IP67/68 / 69K) construction. High quality polishing standard.

Construction: Robust, maintenance-free, welded steel construction, heavy duty design for food industrial use, **Stainless steel** weighing platform, Maintenance-free durable Stainless steel (DIN 1.4301 / IP67/68 / IP 69K

Load cells: Robust, **stainless steel load cell**, IP68, OIML, with a high overload capacity. **Installation:** Adjustable leveling feet, designed for permanent or portable installations, 5m cable to connect digital indicator.

Options: Custom sizes and capacities

Standard indicator: [KPZ 52E91](#), **For approved applications:** [KPZ 52E91](#), **Options for indicators:** Multi range, RS 232 serial interface, Various printers connection, Radio data transfer, WLAN, etc.. Internal battery

Approvals: OIML class III **M**, CE conform. **Power Supply** : 230 V mains, Power cord.

Construction: complete stainless steel version of KPZ 71-7. High quality flat iron construction just constructed for weighing technic. steering wheels: Nylon (Ø 200mm) fork wheels: Tandem Nylon. weighingsystem: 4 high grad, stainless steel loadcells, Type KPZ 502E-3, IP68, EU approval certification class III, accuracy: 0,02%, power supply: Accu, charger incl. Certification: EC approval possibility class III, Declaration of conformity, approved version.

hand pallet weigher KPZ 71-7N stainless steel [Material 1.4301](#)

Typ	Fork Dim. mm	capacity kg	Div. g	Approval possible	Indicator	€/pcs	Article – No.
KPZ 71-7N,	560x1150	2200	500	No	KPZ 52E91/IP67	2975	717N00002200
KPZ 71-7NM,	560x1150	1500/2200	200/500	No	KPZ 52E91/IP67	2975	717NM00002200
KPZ 71-7N,	560x1150	1500	200	No	KPZ 52E91/IP67	2975	717NM00001500
KPZ 71-7N,	560x1150	2.500	200	No	KPZ 52E91/IP67	On Request	717N00001500
KPZ 71E-7N	690x1150	2.200 kg	500 g	No	KPZ 52E91/IP67	On Request	717N07002200
KPZ 71E-7N,	560x1150	600	200g	YES M	KPZ 52E91/IP67	3075	717N0000060E
KPZ 71E-7NM,	560x1150	1500	500g	YES M	KPZ 52E91/IP67	3075	717NM0000150E
KPZ 71E-7N,	560x1150	1.500/2200	500/1000g	YES M	KPZ 52E91/IP67	3075	717NM0000220E
KPZ 71E-7N,	560x1150	2200	1000g	YES M	KPZ 52E91/IP67	3075	717N0000220E
KPZ 71E-7N	690x1150	2.200 kg	1000 g	YES M	KPZ 52E91/IP67	On Request	717N0700220E

Option : Fork height 75 mm or 51 mm

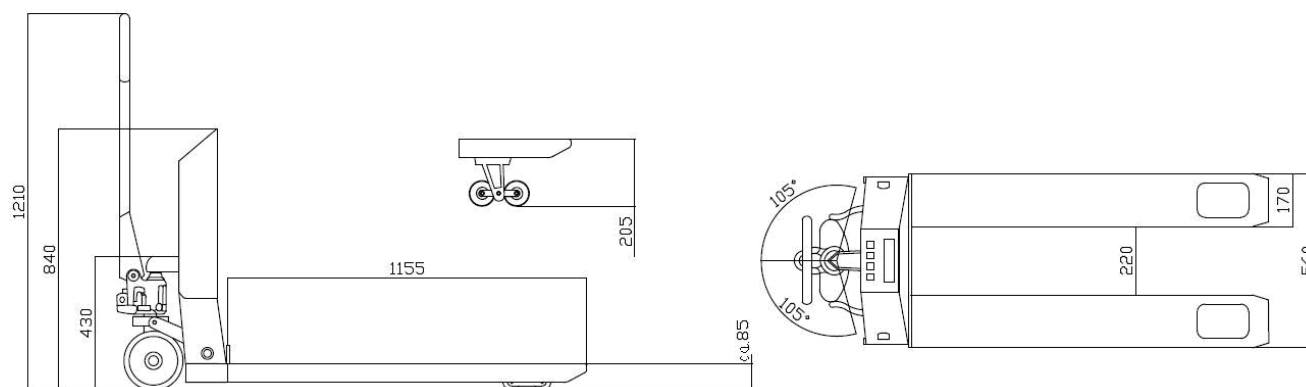

own weight approx. 150 kg.

Stainless steel DIN 1.4301 / 1.4541 / 1.4404 and IP 67/68 + IP 69K version possible

Options? Ask us, we do almost everything possible for you

German design and own EU production guarantees high quality.



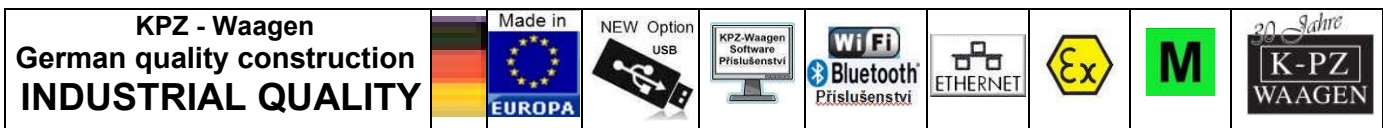

200206 00 BR UK €

Options / accessories / extra charge	€/pcs	Article-No.
Printers: Options (extra cost) + costs for output RS 232		
Indicator KPZ 51E92, IP 67, Hand tareNet/Gross, High/OK/Low	75	71N51E920004
Roller printer FAVORIT Plus, for KPZ 52(E)-*,	on request	120024000000
Label printer and code printer type DR 2 for KPZ 56E-3, KPZ 51E-9-2	on request	120038000000
Print design for DR 2 on request	on request	204333100000
Printer Info and Printout Example		
serial interface / Setpoints: Options / extra costs		
Serial interface RS232 C for KPZ 52E-9-1	20	173071000000
Serial interface RS232 C for KPZ 51E-9-2	20	173072000000
Setpoints, 3 pcs for KPZ 51E-9-2 (more – OK – less)	on request	7152E9200300
Software "KPZ Smart Scale" STANDARD (incl. RS232 serial interface)	75	5S0001000000
Software "KPZ Smart Scale" PROFESSIONAL (incl. RS232 serial interface)	125	5S0005000000
Software "KPZ Smart Scale" PREMIUM (incl. RS232 serial interface)	240	5S0010000000
Wi-Fi Datatransfer	on request	171705000000
construction accessories (extra charge)		
Foot Brake	175	1717N0100000
Factory first certification (extra charge)		
	€/pcs	Artikel-Nr.
For Capacity from 0 kg to 21 kg	50	300PL0000020
For Capacity from 0 kg to 21 kg , Double range	75	300PL0000020
For Capacity from 21 kg bis 200 kg	55	300PL0000504
For Capacity from 21 kg bis 200 kg , Double range	85	300PLM000504
For Capacity from 201 kg bis 500 kg	60	300PL0003004
For Capacity from 201 kg bis 500 kg , Double range	90	300PLM003004
For Capacity from 501 kg bis 3.000 kg	75	300PL0010004
For Capacity from 501 kg bis 3.000 kg , Double range	105	300PLM010004
For Capacity from 3.000 kg bis 10.000 kg	130	300PL0000504
For Capacity from 3.000 kg bis 10.000 kg, Double range	195	300PLM000504

... please contact us for special requests!

Stainless steel DIN 1.4301 / 1.4541 / 1.4404 and IP 67/68 + IP 69K version possible

German design and own EU production guarantees high quality.

Special models are our speciality!



We reserve the right to make technical modifications and price changes without prior notification. Warranty: The parts and components are warranted for two years from the date of delivery against defects in materials and workmanship, provided proper and normal use condition, excluding batteries and chargers.

ATEX compliant KPZ mobile Weighing scale
stainless steel DIN 1.4301 / IP67/68+ IP 69K
EX zone 1+ 2 / EU-approval class M 



KPZ 76F

Typ KPZ 71-7NEX
stainless steel DIN 1.4301



KPZ 73BL



KPZ 717EX2SM



ATEX konform

Mobile weighing Saved working time / simply use, take the Palletweigher, drive directly under the pallet or load, pump up, weighing and drive the load to the point of use.

German design and own EU production guarantees high quality.



ATEX konform

Questionnaire on the implementation of safeguards EX according to ATEX

To check the performance of explosion-proof protection, it is necessary to accurately determine the explosion zone, temperature class and the group of devices according to their degree of hazard analysis. Please include the following information:

The division of zones:

Areas where there may be a dangerous atmosphere, have been divided into zones depending on the probability of the atmosphere EX. There are two kind of atmosphere-gaseous and dusty.

- Gaseous atmosphere 0/20 permanent, long-term or frequent threat (>1.000 h/a)
- 1/21 occasional threat (between 100 and 1.000 h/a)
- Dusty atmosphere 2/22 rare threat (<10 h/a).

Temperature class:

Electric resources Group II were divided into classes according to their maximum surface temperature. Analogically the gas division was made on the basis of different ignition temperatures. The highest permissible surface temperature of resources:

- T1=450° T2=300° T3=200° T4=135° T5=100° T6=85°

Group of devices:

Group I covers all resources, which are admitted to the excavations at risk of an explosive mixture of air and gases(e.g. mines)

Group II applies to areas "on the surface of the earth", for such industries as chemicals, petrochemicals, mills (dust), etc. For protection factor of ignition and compressive strength of the closure housing, another division was made on the basis of different ignition energy of gases (group of devices IIA to IIC).

- I typical gas, e.g. methane , ignition energy 280 μJ
- IIA typical gas, e.g. propane , ignition energy > 180 μJ
- IIB typical gas, e.g. ethylene , ignition energy 60...180 μJ
- IIC typical gas, e.g. hydrogen, ignition energy < 60 μJ.

= not available



KPZ 71-9 / Palletweigher

Standard capacity: 2.200 kg Div. 500g / accuracy 0,05% on the weighing
Weights&measures | powder coating | good value for money | solid



Large LCD display 30 mm high
Display backlight
Large operating keys
Easy to operate
Large battery capacity
Battery : ca.60 hours operating time
Immediately ready for weighing



Option : Printer
 KPZ 71-9 DR

German design and own EU production guarantees high quality. Mobile weighing Saved working time / simply use, take the Palletweigher, drive directly under the pallet or load, pump up, weighing and drive the load to the point of use.

Construction: high quality, for industrial use, solid and stable steel construction. Powder painted blue colour (RAL 5002), welded drawbar, robust forks. Safe, proven in industrial use hydraulics. Large rubber steering wheels Ø 200mm and polyurethan-tandem rolls. Wheels suspension guarantees stability and movement fluency, built in lubrication grease nipples guarantee long operating life of all movable construction parts. Indicator described below is built in a robust steel housing on height comfortable for operator. **Certification:** non approved version and EU type approved version for retail use, CE – conform.

Standard indicator: non approval version: KPZ 52-19, (Details and options for Indicator see data sheet)

Standard indicator: approval version: KPZ 52E-7 (Details and options for Indicator see data sheet)

Power supply : 6V battery, operating time up to 60 hours. Charger included. **Load cells:** High quality load cells KPZ 502E-3, IP 68, OIML C3; EC approval possible

Type	Fork mm	Capacity Kg.	Division	Approval Possible	Indicator	€/pcs	Article-Nr.
KPZ 71-9 S	450x1150	2.200 kg	500 g	No	KPZ 52-19	On Request	719SJ0502200
KPZ 71-9 S	560x1150	2.200 kg	500 g	No	KPZ 52-19	670	719SJ0002200
KPZ 71-9 S	560x1150	2.500 kg	1000 g	No	KPZ 52-19	670	719SJ0002500
KPZ 71-9DR	560x1150	2.200 kg	500 g	No	KPZ 52-19	840	719SJD2200
KPZ71-9S	560 x 800	2.200 kg	500 g	No	KPZ 52-19	750	719S00082200
KPZ71-9S	560x1800	2.200 kg	1000 g	No	KPZ 52-19	1245	719S00182200
KPZ 71-9 S	560x1800	2.500 kg	1.000 g	No	KPZ 52-19	1700	719S00182500
KPZ 71-9 SJ	560x2000	2.200 kg	1.000 g	No	KPZ 52-19	1820	719S00202200
KPZ 71-9 SE	560x1150	2.000 kg	1.000 g	YES	KPZ 52E7	870	719S0020200E
KPZ 71-9 SLE	690x1150	2.000 kg	1.000 g	YES	KPZ 52E7	970	719S0700200E

Option : Underdriving high 75 mm or 51mm

Packing, 1 KPZ 71-9 / Fork : 1150 mm	1600x650x1250 mm, 110 kg / packet on Pallet
Packing, 5 KPZ 71-9 / Fork : 1150 mm	2,30 x 0,60 x 1,00 m, 570 kg / packet in wooden Box

The built-in grease nipples ensure the longevity of all moving construction parts.

Type	Packing dimension
KPZ 71-9	153 x 65 x 125 cm, ca. 115 kg

Technical data – standard specification: **KPZ 71-9 / Palletweigher**

Marking	1.1	Device		Palletweigher	1.1	
	1.2	Type		KPZ 71-9	1.2	
	1.4	Handling		Manual	1.4	
	1.5	Capacity	<i>Q (t)</i>	2,2	1.5	
	1.6	Loading gravity centre	<i>c(mm)</i>	578	1.6	
	1.8	forks surface length from wheel axle	<i>x (mm)</i>	950	1.8	
	1.9	Wheelbase	<i>y (mm)</i>	1200	1.9	
	Weights	2.1	Own weight	<i>kg</i>	110	2.1
		2.2	Axle load with load front / rear	<i>kg</i>	520/1550	2.2
2.3		Axle load without load front / rear	<i>kg</i>	55/34	2.3	
Wheels Undercarriage	3.1	Tyres (full, vukollan, pneumatic, poliurethane)		Rubber/ Polyurethane	3.1	
	3.2	Front wheel dimension		200x40	3.2	
	3.3	Rear wheels dimension		80x70	3.3	
	3.5	Number of wheels		2/4	3.5	
	3.6	Front wheelbase	<i>b₁₀ (mm)</i>	120	3.6	
	3.7	Rear wheelbase	<i>b₁₁ (mm)</i>	390	3.7	
	Basic dimensions	4.4	Lift height	<i>h₃ (mm)</i>	120	4.4
4.9		Drawbar height (in ready to ride position)	<i>h₁₄ (mm)</i>	1225	4.9	
4.15		Height of lowered forks	<i>h₁₃ (mm)</i>	87	4.15	
4.19		Length total without load	<i>l₁ (mm)</i>	1570	4.19	
4.20		Length including forks surface	<i>l₂ (mm)</i>	415	4.20	
4.21		Total width	<i>b₁ (mm)</i>	560	4.21	
4.22		Fork teeth dimension	<i>s/e/l (mm)</i>	74x171x1155	4.22	
4.25		External forks width	<i>b₅ (mm)</i>	560	4.25	
4.32		Ground clearance, central between axles	<i>m₂ (mm)</i>	12	4.32	
4.33		Width of operating space for pallet 1000 x 1200	<i>A_{st} (mm)</i>	1880	4.33	
4.34		Width of operating space for pallet 800 x 1200	<i>A_{st} (mm)</i>	1760	4.34	
4.35		Turning radius	<i>W_a (mm)</i>	1310	4.35	
Performance		5.3	Lowering time with/without load	<i>mm/s</i>	0,09/0,02	5.3

The built-in grease nipples ensure the longevity of all moving construction parts.
Options? Ask us, we do almost everything possible for you

KPZ 71-8 / Palletweigher

(pallet truck with scale)

Standard capacity: 2.200 kg Div. 200g / accuracy 0,02% on the weighing

Weights&measures | powder coating | good value for money | solid

As Option possible : OIML Class  **M** SOLAS konform



Option : Printer KPZ 71-8

Indicator in steel housing
Easy to operate
Industrial quality
Tandem rollers
6 Digit 25 mm high LCD Display
100% tare / multi tare
Switch net and gross
Good read out
Option:
EC approval possibility: Class  **Printer**

Better quality !!! KPZ applies only EU approved components

Weighning Economy plus ! = Saved working hours

The built-in grease nipples ensure the longevity of all moving construction parts.

German design and own EU production guarantees high quality. Mobile weighing Saved working time / simply use, take the Palletweicher, drive directly under the pallet or load, pump up, weighing and drive the load to the point of use.

Construction: high quality, for industrial use, solid and stable steel construction. Powder painted yellow colour (RAL 1003), welded drawbar, robust forks. Safe, proven in industrial use hydraulics. Large rubber steering wheels Ø 200mm and polyurethan-tandem rolls. Wheels suspension guarantees stability and movement fluency, built in lubrication grease nipples guarantee long operating life of all movable construction parts. Indicator described below is built in a robust steel housing on height comfortable for operator. **Certification:** non approved version and EU type approved version for retail use, CE – conform.

Standard indicator: non approval version: KPZ 52-72 (Details and options for Indicator see data sheet)

Standard indicator approval version: KPZ 52E-7 (Details and options for Indicator see data sheet) **Power supply :** 6V battery, operating time up to 60 hours. Charger included. **Load cells:** High quality load cells KPZ 502E-3, IP 68, OIML C3; EC approval possible.

Typ	Fork Dim.mm	Capacity kg	Div.	Approval	Indicator:	€/pcs	Article – No.
KPZ 718SJ	450x1150	2200 kg	100 g	No	KPZ 5272	On Request	718S050002200
KPZ 718SJ	560x1150	2200 kg	100 g	No	KPZ 5272	830	718SJ00002200
KPZ 718SJ	560x1150	2200 kg	200 g	No	KPZ 5272	815	718SJ00002200
KPZ718SMH	560x1150	1100/2200	100/200 g	No	KPZ 5272	815	718SMH002200
KPZ 718S	560x1150	2500 kg	1000 g	No	KPZ 5272	800	718S000002500
KPZ 718S	560x1150	3000 kg	1000 g	No	KPZ 5272	1400	718S000003000
KPZ 718SL	690x1150	2.200 kg	500 g	No	KPZ 5172	On Request	718S07002200
KPZ 718SE	560x1150	600kg	200 g	YES	KPZ 52E7	960	718S0000060E
KPZ 718SE	560x1150	1500kg	500 g	YES	KPZ 52E7	960	718S0000150E
KPZ 718SE	560x1150	2200kg	1000 g	YES	KPZ 52E7	960	718S0000220E
KPZ 718SME	560x1150	1100/2200kg	500/1000 g	YES	KPZ 52E7	960	718SM000220E
KPZ 718SE	560x1150	2500kg	1000 g	YES	KPZ 52E7	960	718S0000250E
KPZ 718SE	560x1150	3000kg	1000 g	YES	KPZ 52E7	1595	718S0000300E
KPZ 718SEL	690x1150	1100/2200kg	500/1000 g	YES	KPZ 52E7	On Request	718SM700220E

Option : Fork high 75 mm or 51 mm

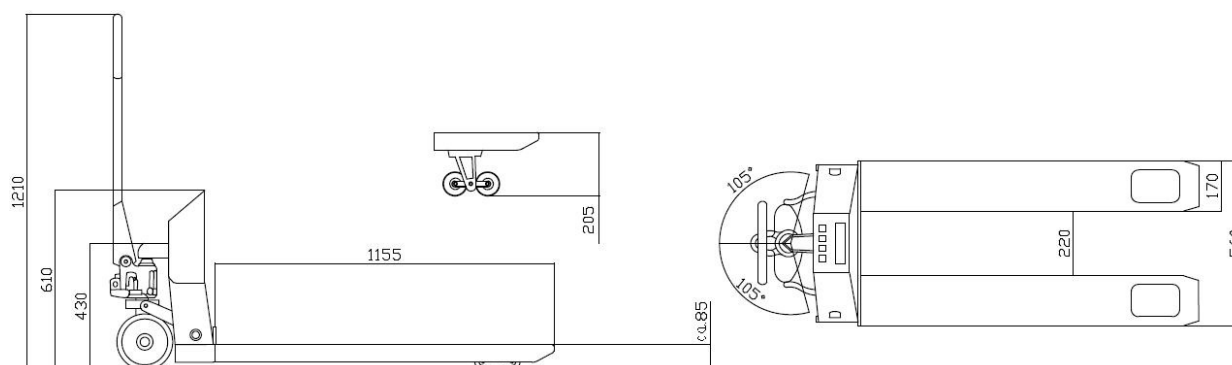

Type	Packing dimension
KPZ 71-9	153 x 65 x 125 cm, ca. 155 kg



Options? Ask us, we do almost everything possible for you
German design and own EU production guarantees high quality.

The built-in grease nipples ensure the longevity of all moving construction parts.



KPZ 71-7 / hand pallet truck with integrated scale  
solid and stable steel construction designed for weighing, powder painted
Capacity 2.000 kg | Division : 100g , 200 g, 500g | **accuracy: 0,02 %**
the world highest accuracy in mobile scales



Standard capacity: 2.200kg

Long exploitation period thanks to lubrication grease nipples

Easy to operate

Large Operating Keys



Industrial quality

Independent of Mains Power

Large Battery Capacity

6 Digit 25mm high LCD Display

100 % Tare

Good Read-out

High Accuracy

Back light

Tandem rollers







Options:

Printer

Weight Range: up to 3.000 kg

We will do for you almost everything

Options:

Narrow	Long/shorter	Wide	Turnable Indicator	Change-Battery	Wi-Fi
					

Better quality! KPZ applies only EU approved components

Mobile Weighing ? = Saved working hours & money!

The built-in grease nipples ensure the longevity of all moving construction parts.

EU-approval class **M** Klasse III

Typ	Fork Dim. mm	Capacity kg	Div. g	Approval possible	Indicator:	€/pcs	Article – No.
KPZ 717SJ	450x1150	1200 kg	100 g	No	KPZ 5272	On Request	717SH50002200
KPZ 717SJ	560x1150	1200 kg	100 g	No	KPZ 5272	905	717SH00002200
KPZ 717SJ	560x1150	2200 kg	100 g	No	KPZ 5272	910	717SH00002200
KPZ 717SJ	560x1150	2200 kg	200 g	No	KPZ 5272	905	717SJ00002200
KPZ 717SMH	560x1150	1100/2200	100/200 g	No	KPZ 5272	905	717SMH002200
KPZ 717S	560x1150	2500 kg	1000 g	No	KPZ 5272	910	717S000002500
KPZ 717S	560x1150	3000 kg	1000 g	No	KPZ 5272	1430	717S000003000
KPZ 717SL	690x1150	2.200 kg	500 g	No	KPZ 5272	On Request	717S07002200
KPZ 717SE	560x1150	2200 kg	1000 g	YES	KPZ 52E7	990	717S0000220E
KPZ 717SE	560x1150	1500 kg	500 g	YES	KPZ 52E7	990	717S0000150E
KPZ 717SE	560x1150	600 kg	200 g	YES	KPZ 52E7	990	717S0000060E
KPZ 717SME	560x1150	1100/2200	500g/1000	YES	KPZ 52E7	995	717SM000220E
KPZ 717SE	560x1150	2500 kg	1000 g	YES	KPZ 52E7	1040	717S0000250E
KPZ 717SE	560x1150	3000 kg	1000 g	YES	KPZ 52E7	1630	717S0000300E
KPZ 717SE	690x1150	1100/2200	500g/1000	YES	KPZ 52E7	On Request	717S0700220E

Option : Fork high 75 mm or 51 mm

Construction : KPZ 71-7 mobile palletweigher: high quality, for industrial use, long exploitation period, very solid and stable steel construction, designed for weighing, powder painted, yellow color (RAL 1003), welded drawbar; strong forks made from 0.16"/4-mm steel plate. Safe, proven in industrial use hydraulics. Large, rubber steering wheels, diameter 7.87"/200 mm. Wheels suspension guarantees stability and movement fluency, built in lubrication grease nipples guarantee long operating life of all movable construction parts. Indicator described below is built in a robust steel housing on height comfortable for operator. **Indicator:** KPZ 52E-7 (possibility to deliver other one, indicated by a customer as an option). **Load cells:** High quality load cells KPZ 502E-3, IP 68, OIML C3; EC approval possible. **Certification:** EC approval possibility class III, declaration of conformity, approved version).

Power supply: 6V battery, operating time approx 36 hours, re-charging time max. 10 hours (normally carried out overnight). Charging device is included in unit price.

KPZ 52-7-2

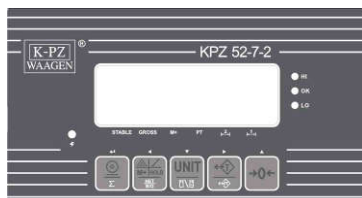

KPZ 52E – 7



Features: Built in a stable, robust steel housing, Large user-friendly, membrane keyboard, 5 large control buttons. Easy to read, back-lit LCD - display, 6 digits, with 1.2"/30mm high digits.

Functions: Automatic and manual zero correction, Up to 100 % Tare, Gross - / Net switch, Minus indication, Piece counting by means of reference quantity selectable between 10, 20, 50, 100 and 200 pieces, Set point module HIGH-OK-LOW (i.e. two selectable weight values, color LED display), automatic self-test,

Features: High resolution and fast weight display. Built in a stable, robust steel housing, user-friendly, dust and waterproof membrane keyboard, 4 large control buttons. LCD - display, 6 digits, 1.18"/30mm high digits, backlit. For approved weighing applications.

Functions: Automatic and manual zero correction →0←, Up to 100 % Tare ↕, Gross - / Net switch ^{NET}GROSS, Minus indication, Set point module HIGH-OK-LOW (ie two selectable weight values, LED display), Automatic selftest

Technical data: working temperature 14°F up to 104°F Dimensions. 10.16'x8.35'x4.57' (WxLxH)

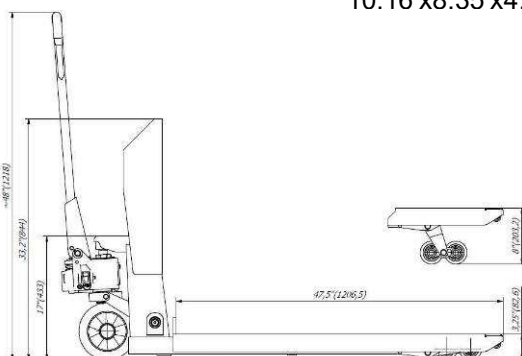

Pallet truck with integrated scale, Type KPZ 71-7 Favourite

Marking	1.1	Device		Palletweigher	1.1	
	1.2	Type		KPZ 71-7	1.2	
	1.4	Handling		Manual	1.4	
	1.5	Capacity	Q (t)	2,2	1.5	
	1.6	Loading gravity centre	c(mm)	578	1.6	
	1.8	forks surface length from wheel axle	x (mm)	950	1.8	
	1.9	Wheelbase	y (mm)	1200	1.9	
	Weights	2.1	Own weight	kg	142	2.1
		2.2	Axle load with load front / rear	kg	520/1550	2.2
2.3		Axle load without load front / rear	kg	55/34	2.3	
Wheels Undercarriage	3.1	Tyres (full, vulkollan, pneumatic, poliurethane)		Rubber/ Polyurethane	3.1	
	3.2	Front wheel dimension		200x40	3.2	
	3.3	Rear wheels dimension		80x70	3.3	
	3.5	Number of wheels		2/2 or 2/4	3.5	
	3.6	Front wheelbase	b ₁₀ (mm)	120	3.6	
	3.7	Rear wheelbase	b ₁₁ (mm)	390	3.7	
	Basic dimensions	4.4	Lift height	h ₃ (mm)	120	4.4
4.9		Drawbar height (in ready to ride position)	h ₁₄ (mm)	1225	4.9	
4.15		Height of lowered forks	h ₁₃ (mm)	87	4.15	
4.19		Length total without load	l ₁ (mm)	1570	4.19	
4.20		Length including forks surface	l ₂ (mm)	415	4.20	
4.21		Total width	b ₁ (mm)	560	4.21	
4.22		Fork teeth dimension	s/e/l (mm)	74x171x1155	4.22	
4.25		External forks width	b ₅ (mm)	560	4.25	
4.32		Ground clearance, central between axles	m ₂ (mm)	12	4.32	
4.33		Width of operating space for pallet 1000 x 1200	A _{st} (mm)	1880	4.33	
4.34		Width of operating space for pallet 800 x 1200	A _{st} (mm)	1760	4.34	
4.35		Turning radius	W _a (mm)	1310	4.35	
Performance		5.3	Lowering time with/without load	mm/s	0,09/0,02	5.3



German design and own EU production guarantees high quality.

The built-in grease nipples ensure the longevity of all moving construction parts.

14 KPZ-Váhy s.r.o. • Libošovice 76 • CZ507 44 Libošovice • GSM: 00420736622710 • Email: zander@kpzwaagen.de • **KPZ-Waagen - 30years - AFFORDABLE, ROBUST and GOOD !!** www.kpzwaagen.com

We reserve the right to make technical modifications and price changes without prior notification. Warranty: The parts and components are warranted for **two years** from the date of delivery against defects in materials and workmanship, provided proper and normal use condition, excluding batteries and chargers.

Pallet truck with integrated scale, Type KPZ 71-7 Favourite - Construction

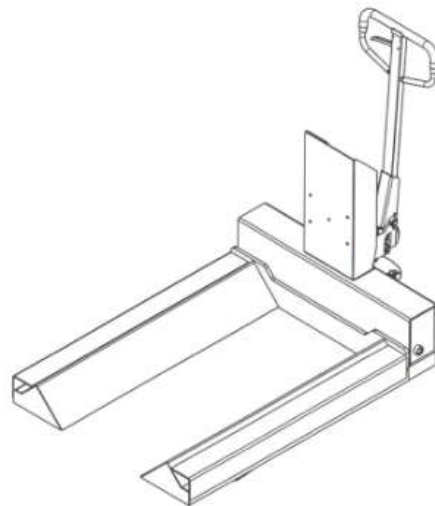
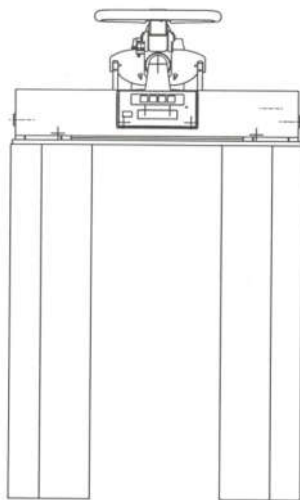
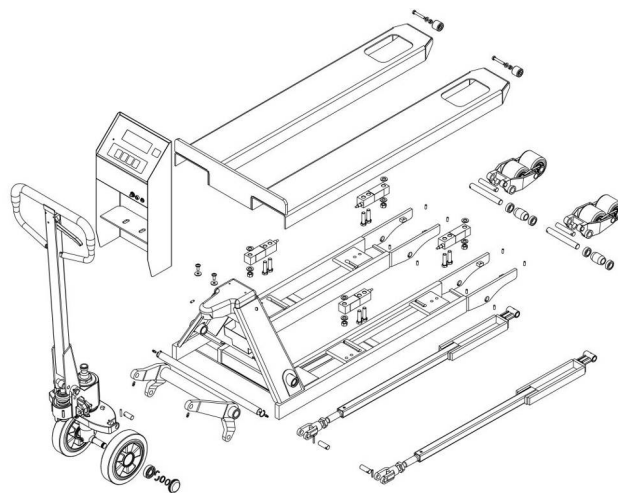
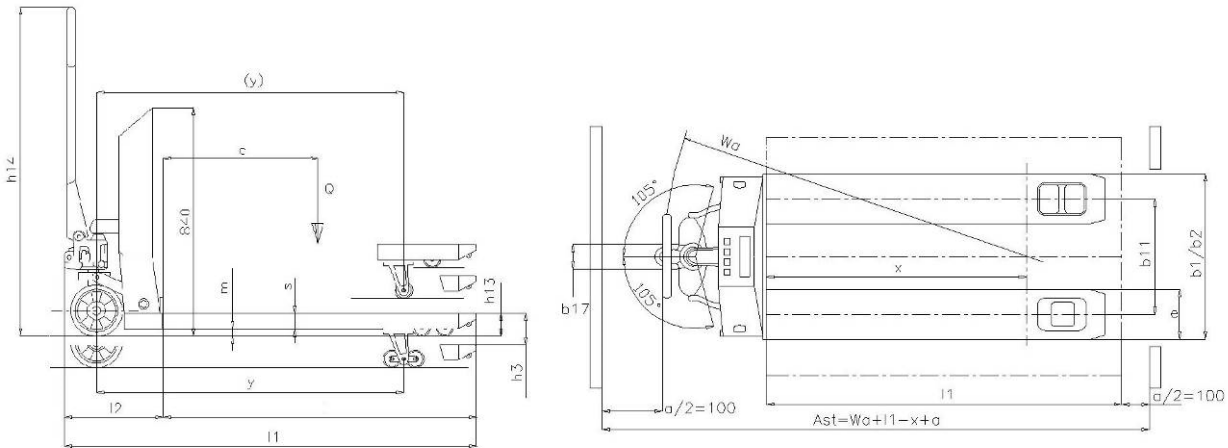

The built-in grease nipples ensure the longevity of all moving construction parts.

German design and own EU production guarantees high quality.



KPZ 71-7



Other capacity, division, option and dimension on request.

German design and own EU production guarantees high quality.

The built-in grease nipples ensure the longevity of all moving construction parts.



Options / accessories / extra charge	€/ pcs	Article-Nr
Indicators: Options (extra cost)		
Indicator KPZ 52E-7/1, with pre tare and easy counting instead of KPZ 52E-7	15	7152E7100000
Indicator KPZ 52E-9/1, with pre tare and easy counting instead of KPZ 52E-7	120	7152E9100000
Indicator KPZ 52E-9/2, with pre tare and easy counting instead of KPZ 52E-7	185	7151E9200000
Indicator KPZ 56E-4, professional counting, addition, Tare input by hand, instead of KPZ 52E7	20	7156E4000000
Indicator KPZ 58-2, Reference counting, addition, Tare input by hand, instead of KPZ 52E-7	290	171330000000
Printers: Options (extra cost) + costs for output RS 232		
Roller printer FAVORIT Plus, for KPZ 51(E)-*,	155	171023000000
Label and Code Printer DR 6 for KPZ 56E4	455	171334000000
Print design on request	on request	204333100000
serial interface / Setpoints: Options / extra costs		
Serial interface RS232 C for KPZ 52E-7	30	7152E7000100
Serial interface RS232 C for KPZ 52-15	20	715272000100
Serial interface RS232 C for KPZ 52E-9-1	20	7152E9100100
Serial interface RS232 C for KPZ 51E-9-2	20	7152E9200100
Serial interface RS232 C for KPZ 56E-4 incl. PT and Addition	45	7156E4000100
Serial interface RS232 C for KPZ 56E-4 incl. RTC, w/out PT, w/out Addition	55	7156E4000200
Setpoints, 3 pcs for KPZ 52(E)-8 (more – OK – less)	On Request	7152E7000300
Software "KPZ Smart Scale" STANDARD (incl. RS232 serial interface)	75	5S0001000000
Software "KPZ Smart Scale" PROFESSIONAL (incl. RS232 serial interface)	125	5S0005000000
Software "KPZ Smart Scale" PREMIUM (incl. RS232 serial interface)	240	5S0010000000
Wi-Fi Datatransfer	on request	171705000000

Construction options		
Hand break	105	171701000000
Feet break	55	171701000001
Turning housing for indicator KPZ 51E-7, range 320°	130	17151E704400
Quicklifting for KPZ 71-7	85	171700313000
Load wheel / Nylon	25	171415000000
Load wheel / Nylon, tandem	25	171415100000
Steering wheel / Nylon	25	171417000000
Steering wheel / Polyurethane	30	171417100000
Other forks width, 480 mm to 680 mm	615	171311000000
Other forks length, 850 mm to 1550 mm	420	171310000000
Other forks length, 1600 mm to 1800 mm	1035	171320000000
Other forks length, 2000 mm and longer	on request	171502050000
Galvanized version, nickel-plated load cells	on request	171412000000
Forks cover plate, stainless steel	340	171413200000
1 set of nickel- plated load cells KPZ 71-*	on request	171413100000
Exchangable battery	140	171704000000

Factory first certification (extra charge)	€/pcs	Artikel-Nr.
For Capacity from 0 kg to 21 kg	50	300PL0000020
For Capacity from 0 kg to 21 kg , Double range	75	300PL0000020
For Capacity from 21 kg bis 200 kg	55	300PL0000504
For Capacity from 21 kg bis 200 kg , Double range	85	300PLM000504
For Capacity from 201 kg bis 500 kg	60	300PL0003004
For Capacity from 201 kg bis 500 kg , Double range	90	300PLM003004
For Capacity from 501 kg bis 3.000 kg	75	300PL0010004
For Capacity from 501 kg bis 3.000 kg , Double range	105	300PLM010004
For Capacity from 3.000 kg bis 10.000 kg	130	300PL0000504
For Capacity from 3.000 kg bis 10.000 kg, Double range	195	300PLM000504

... please contact us for special requests!

The built-in grease nipples ensure the longevity of all moving construction parts.

. German design and own EU production guarantees high quality.



KPZ 74 / scissorlifts with scale  

Weights&measures | powder coating | good value for money| solid



KPZ 74 semi electric scissor truck

The weighing System is German design and own EU production guarantees high quality.

Mobile weighing Saved working time / simply use, take the Palletweigher, drive directly under the pallet or load, pump up, weighing and drive the load to the point of use.

Construction: high quality, for industrial use, solid and stable steel construction. Powder painted blue colour, welded drawbar, robust forks. Safe, proven in industrial use hydraulics. Large rubber steering wheels Ø 200mm and polyurethan-tandem rolls. Wheels suspension guarantees stability and movement fluency, built in lubrication grease nipples guarantee long operating life of all movable construction parts. Indicator described below is built in a robust steel housing on height comfortable for operator. **Certification:** non approved version, CE – conform.

Standard indicator: non approval version: KPZ 52-19 (Details and options for Indicator see data sheet)

Standard indicator approval version: KPZ 52E-7 (Details and options for Indicator see data sheet). **Power supply :** 6V battery, operating time up to 60 hours. Charger included. **Load cells:** High quality load cells KPZ 502E-3, IP 68, OIML C3; EC approval possible

Typ	Lifting high	Capacity	Division	Approval possible	Indicator	€/pcs	Article No.
KPZ 74 SJ		1000 kg	500 g	No	KPZ 5219	1580	74000001000
KPZ 74 SE		1000 kg	1000 g	YES 	KPZ 52E7	1735	7400000150E

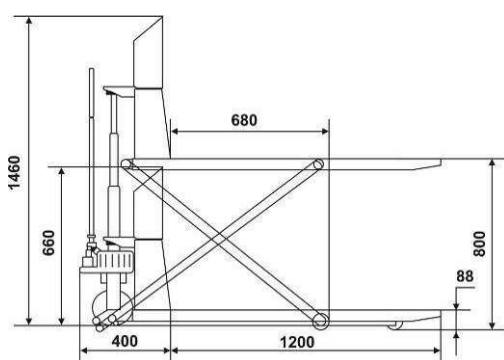

Dim. in mm

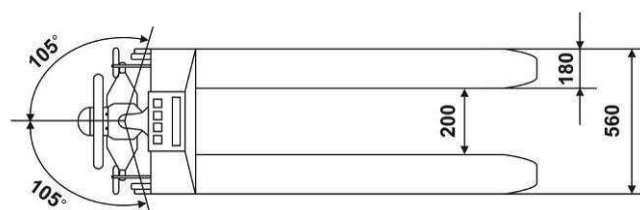

Options? Ask us, we do almost everything possible for you

German design and own EU production guarantees high quality.

KPZ Indicators

 <p>Klasse III M</p> <p>KPZ 52E-7</p>	 <p>Klasse III M</p> <p>KPZ 52E-7/1</p>	 <p>Klasse III M</p> <p>KPZ 56E-4</p>
 <p>Klasse III M</p> <p>KPZ 52E-9-1</p>	 <p>Klasse III M</p> <p>KPZ 51E-9-2</p>	 <p>KPZ 51E11 - 13</p>
 <p>Klasse III M</p> <p>KPZ 58-2</p>	 <p>KPZ 52-19</p>	 <p>Big display/second display</p>
 <p>Klasse III M</p> <p>KPZ 54E-*</p>	 <p>Klasse III M</p> <p>KPZ 54E-*</p>	

We reserve the right to make technical modifications and price changes without prior notification

KPZ Indikátory



Indikátor KPZ 52E – 8



Indikátor KPZ 52E7

Klasse



Multirange division : See technical data of the scale. OIML Class



Description KPZ 52(E) - 7

Robust external case made from ABS incorporating a water-proof front keypad with large function keys. 6-digit, 26 mm high LCD – Display with back-light function providing a clear and easily readable weight indication. Operating temperature – 10 to + 40 °C. 230 Volt-operation.

Function : automatic and manual Zero setting. Tare setting up to 100 %, switch Net and gross weight repeatedly. Optional RS 232 Data output and addition sum printing, minus indication, LCD back-light (3 settings), audible/visible alarm/check HIGH-OK-LOW (That means two available value of weight), automatic selftest, Error message on display.

LED indication for : Zero, Tare weight, stabile, LOW Bat, power, addition memory.





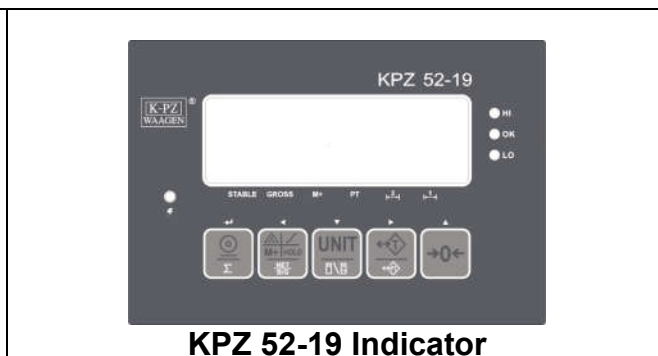

Options: Configurable RS 232 output, data output (different formats), Roller printer, label printer, set point (High-OK-Low),

Key	Description
ON/OFF	This key is installed on the ABS housing. This key is used to switch the indicator ON or OFF. When activated the display shows the $\rightarrow 0 \leftarrow$ signal is on.
$\rightarrow 0 \leftarrow$	If the LCD Display is not indicating 0.00 , press this key to re-zero the scale. The display indicates that the ZERO signal is now on. The unit can zero $\pm 2\%$ of the max. capacity. Using this switch do not change the range of maximal capacity.
$\leftrightarrow T$	This key is used to carry out tare and zero settings, when an existing weight is on the scale. If a TARE weight is stored, the Tare Signal will indicate over Net . As soon as you remove the TARE weight re-set to ZERO by the user of the scale, the display shows the weight with a minus symbol in front on the LCD display. The maximum weighing range is reduced for the tare value. Tare capability is 100% of the scale capacity, and can be used repeatedly. Multiple tare is possible. Negative weight values can be moved to 0.00 .
NET GROSS	This key is used to switch between net and gross weight repeatedly. The display indicate Net or τ GROSS. This $\frac{NET}{GROSS}$ key can be used only when the scale is in the tare mode. By showing the Gross value (τ GROSS) the other keys are closed.
	If a printer interface is installed, this key will print out (printer version) or transfer the weight data being displayed . The weight value is stored in the data logger. The display indicate τ M+ .To print the grand total of all printed weights the weight must be removed. The display shows $\rightarrow 0 \leftarrow$. Then press the  key twice the total sum of the weighing results will be printed .

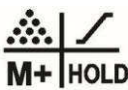
KPZ Indicators



Robust external case including a water-proof front keypad with large function keys. 6-digit, 30 mm high LCD – Display with blue back-light function providing a clear and easily readable weight indication. Operating temperature – 10 to + 40 °C. 230 Volt-operation. Battery operation possible. **Function** : automatic and manual Zero setting. Tare setting up to 100 %, pretare function, switch Net and gross weight repeatedly. Optional RS 232 Data output and addition sum printing, minus indication, HIGH-OK-LOW function, totalizing function, automatic selftest, Error message on display. **LED indication for** : Zero, Tare weight, stable, LOW Bat, HI LOW OK .
Options: RS 232 output, data output, Roller printer,

Key	Function	Hold for 1 sec.
	Printout / data output (Option)	Communication settings
Σ	Totalizing	
	Modus selection / Function	
	Switching between net and gross weight (net mode)	
UNIT	switching units	
	Switch between weight / unit weight (piece counting mode)	
	Tare	<ol style="list-style-type: none"> 1. Backlight 2. Switch on zero setting 3. Gravitation value
	Pretare	
	Zero	battery voltage

KPZ Indicators

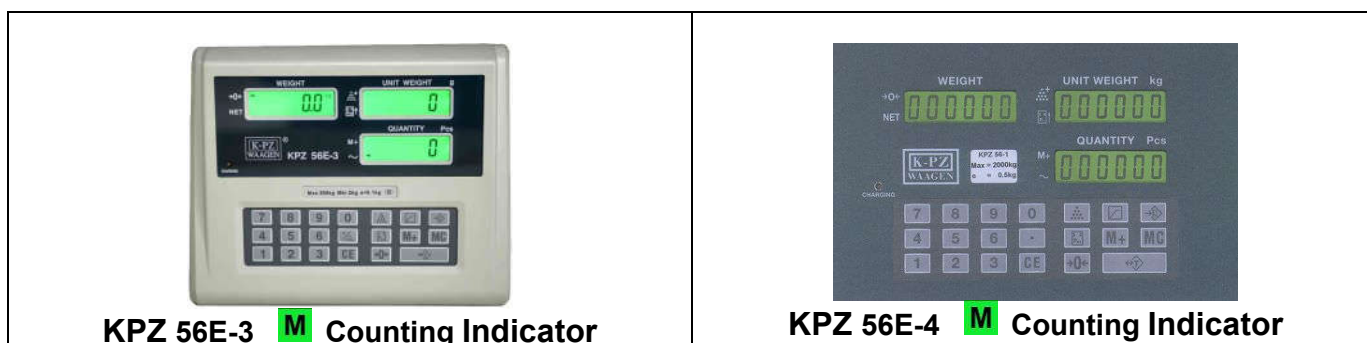



KPZ 56E-3  **Counting Indicator**

KPZ 56E-4  **Counting Indicator**

Optimal unit weight for the piece count: 1/5 of the scale division.

This high-quality Parts Counting Indicator can be used in all types of uncertified and for trade weighing applications. Due to the high external resolution and the 20x expanded internal resolution, the unit is ideally suitable for both small and large item component counting. The expanded internal resolution of the indicator provides clear signal stability and repeatability. The 3 window highly visible LCD-Display provides the operator with clear data information. Additionally, with the robust construction of a steel housing, built-in rechargeable battery, and the simple to operate dust and waterproof front keypad, makes this part counting indicator a valuable tool for all industrial weighing & counting applications.

Description of Keypad

0 to 9 and .	Use to enter piece weight, total quantity or Tare value.
CE:	Deletes all value entered via the keypad.
→0←	1) Use this key to Zero the scale 2) Use this key by pressing twice to enter backlight options (see Backlight Function)
↕	Use this key to Tare the scale
	Use this key to confirm entered quantity.
	Use this key to confirm entered piece weight.
	Use this key to pre-set upper count limit, when the value is achieved an audible signal will be emitted.
→H←	Use this key to save a piece weight in memory.
M+	Count accumulation key.
MC	Deletes all accumulation count in memory.

Standard features :Indicator: Display indication 1/30.000, internal divisions 1/600.000. Built-in calibration routine. Automatic & manual zero setting. 100% Tare. Piece Counting. The tare value and the piece weight can be weighed or entered via the front keyboard. The indicator has a 10 piece weight memory. 3 window LCD display with back-lighting option showing weight, quantity and individual piece weight. Counting accumulation. Audible peak alarm for Multi counting applications. Symbol indication shown at display for : Power re-charging control, LO-BAT. Zero, Tare, Stable, Memory, Piece number, Piece weight.

Options :

Factory configured serial interface (RS 232). With this interface in addition to date, weight & count information, two additional 15 character line entries can be included (for example Item number, operator number etc.) Printing from this interface via a single tally roll printer or label printer which will print all data in a numerical format, or in a range of standard **Barcodes**.

KPZ Indicators

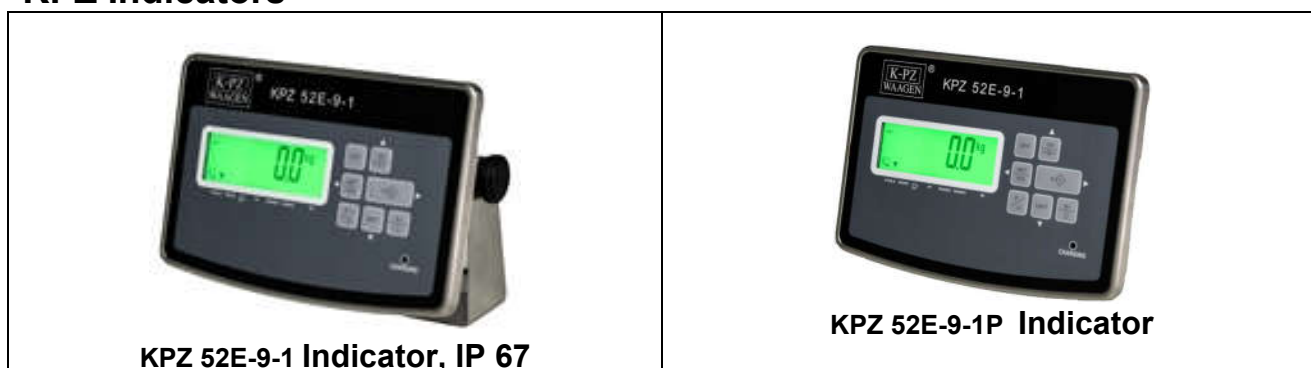

KPZ 52E-9-1 Indicator, IP 67

KPZ 52E-9-1P Indicator

OIML trade approved Class III **M**, 10.000 e

Technical data: Indicator: **KPZ 52E-9-1** robust, stainless steel housing **IP 67**, user-friendly, large function keys. LCD display: 6 digit, various symbols, backlight, high of digits 25 mm. Operating temperature from -10°C up to $+40^{\circ}\text{C}$, operation 230 Volt through external power supply, inbuilt battery (possibility of battery operation).

Functions: automatic and manual zero setting, switch Net/Gross weight, 100% tare, multiple tare, unit switching, simple piece counting by reference no. 10, 20, 50, 100 i 200. Possibility to enter data and bring out data through serial interface (optional): computer functional control, possibility of choosing different exit formats, **printout in simple format**, edition activation: via computer, continuously or after zero come back. Minus indication, LCD backlight, automatic shut off after 0-9 minutes, pre-set value control or limit value control LOW – OK - HIGH (any two weight values to choose, tone or light signal), electronic stabilization filter and signal distortion, automatic self test, error messages.

Indication: zero setting, gross, net, stability, LOW-Bat indication, pre-set/limit value, too small piece quantity or too small weight. **LED:** charging status. **Options:** serial interface RS 232, battery, label printer

Key functions:

Key	Description
ON	<i>switch the indicator ON</i>
→0←	<i>Switch the indicating to 0.00</i>
OFF	<i>switch the indicator OFF</i>
↔T	<i>TARE function</i>
NET GROSS	<i>Switch over Net / Gross Tare, repeatedly</i>
UNITS	<i>Switch over weighing units</i>
F/HR	<i>In approval version: High resolution indication (5 sec)</i>
M+	<i>Totalizing and printout/ data output</i>

Robust external case including a water-proof front keypad with large function keys. 6-digit, 30 mm high LCD – Display with blue back-light function providing a clear and easily readable weight indication. Operating

KPZ 54-* / Touch screen indicator



- Touch Operating System for user friendly and fastest operations.
- Multi-printer selectable
- Custom printout options,
- Multi -language support
- Report management.
- PC keyboard and Mouse can be connected
- Software upgrade option.
- 9999 products possible to store in memory.
- designed for multiple use, such as Weighing, Target, Counting, Check weighing and Recipe operations.
- 2xUSB port, 1xRS232, optional more ports possible
- 7' or 8' display possible
- Robust ABS or stainless steel housing possible
- Dual scale option (extra charge) possibility



KPZ 51E-45K

IP69K

AISI 304 stainless steel weight Indicator (dimensions: 206x286x108 mm) with 6 PG9 cable glands, **IP69K protection rating**, stainless steel adjustable bracket included (overall dimensions with bracket: 206x290x187 mm). Optionals: panel / desk / column mounting. Six-key membrane keyboard with buzzer. Real-time clock with buffer battery.

Weight reading by another instrument via serial port.

Two serial ports (RS232 and RS485) for connection to:

- PC/PLC up to 32 instruments (max 99 with line repeaters) by ASCII protocol or ModBus RTU.
- Remote display.
- Printer.

- Optional integrated output: Profibus DP, DeviceNet, CANopen, Profinet IO, Ethernet/IP, Ethernet TCP/IP, Modbus/TCP.

Main functions:

- 5 setpoints (4 setpoints if Analog Output is present) configurable as normally open or normally closed. The operator can decide the setpoints activation for the net weight value, gross weight value, otherwise for positive weights or for positive and negative weights.
- Counting.
- Totalizing.
- Setting of hysteresis value for each setpoint.
- 12 groups selection by 5 setpoint from selector switch or contacts (EC/E options).
- Peak holder displaying by closing the Peak contact.
- Net/Gross function by keyboard or external contact.
- Manual adjustment of zero value in case of zero-setting not possible.
- Auto zero function.
- Auto zero-tracking function.
- Print of the weight via keyboard or external contact with date and time.

Operation: The inputs can work as: net/gross weight, zero-setting, peak, print or can be remotely read via protocol.

The outputs can work as setpoints or can be remotely switched via protocol.

Weight transmitter approved OIML R61 (Automatic Gravimetric Filling Instruments) according to WELMEC Guide 8.8:2011 (MID).

approvable EN45501-2014/31/UE-OIML R76:2006

- Maximum number of verification scale intervals n=10000
- Minimum input-voltage per VSI 0.2 µV
- Weighing range single range or multi range (max 3) or multi interval (max 3)
- Calibration via keyboard is protected through seals for the access to a setting jumper or installer password
- Semi-automatic zero and tare, predetermined tare functions.
- Weight subdivisions displaying (1/10 e)
- The following values can be printed from external contact: net/gross weight; tare; predetermined tare; date; time; ID code (if alibi memory is present)



KPZ 51E-41 indicator

Characteristics:

Software: Base

- Zeroing
- Tare
- Hand tare
- Gross / Net switching
- simple piece counting
- Add function
- automatic zeroing function

Function (Optional):

- Print function including date and time, external button
- I / O inputs as net / gross switching, zeroing, peak value, printout
- I / O outputs as set point function
- Communication protocol via serial interface
- 5 set points (4 set points if analogue output is available) Configurable as open or normally closed. The set points can be set as net weight, gross weight, for positive or for positive and negative weights.
- Setting the hysteresis value for each set point.

Option (extra charge):

- Wall mounting
- Stand
- Battery
- Alibi memory
- Analog output
- I/O's, relay output
- Printer
- Serial interface RS232 and RS485
- Remote display
- Profibus, Ethernet TCP/IP, Modbus, CANopen, DeviceNet.

Power supply:

- Mains 110-240VAC, 3m long cable

Technical Data:

- LCD display, backlit (6 digit 20mm high, semi alphanumeric)
- 16 icon displays
- Robust ABS housing IP67
- Temperature range: -10 ° C to 40 ° C
- dim. 122x226x164mm
- EU type approval Class III to 10,000e

Big display (second display), can be combined with all KPZ Indicator

Model : KPZ GD 1-1

150057052000 Large display KPZ GD1-1, 6-digit, 127 mm LED dot matrix, with 5m connection cable and interface for connection to the display KPZ 52 (E) - *

Model : KPZ GD 2

150057062000 Großanzeige KPZ GD2-1 6-stellig, 76 mm LED's dot Matrix, mit 5m Anschlußkabel und Interface zum Anschluß an die Anzeige KPZ 52 (E)-*



PC Software K-PZ Smart Scale

Software K-PZ Smart Scale is a modern software specially designed to manage weighing data. A custom function selection is possible depending on different stages of development. Moreover, it is possible to customize software according to customer requirements.

It provides an extremely user-friendly interface and easy of operation.

Software used to manage weighing data, transmitted via the interface of the scale.

It saves time and transmission errors that may occur by manual data input.

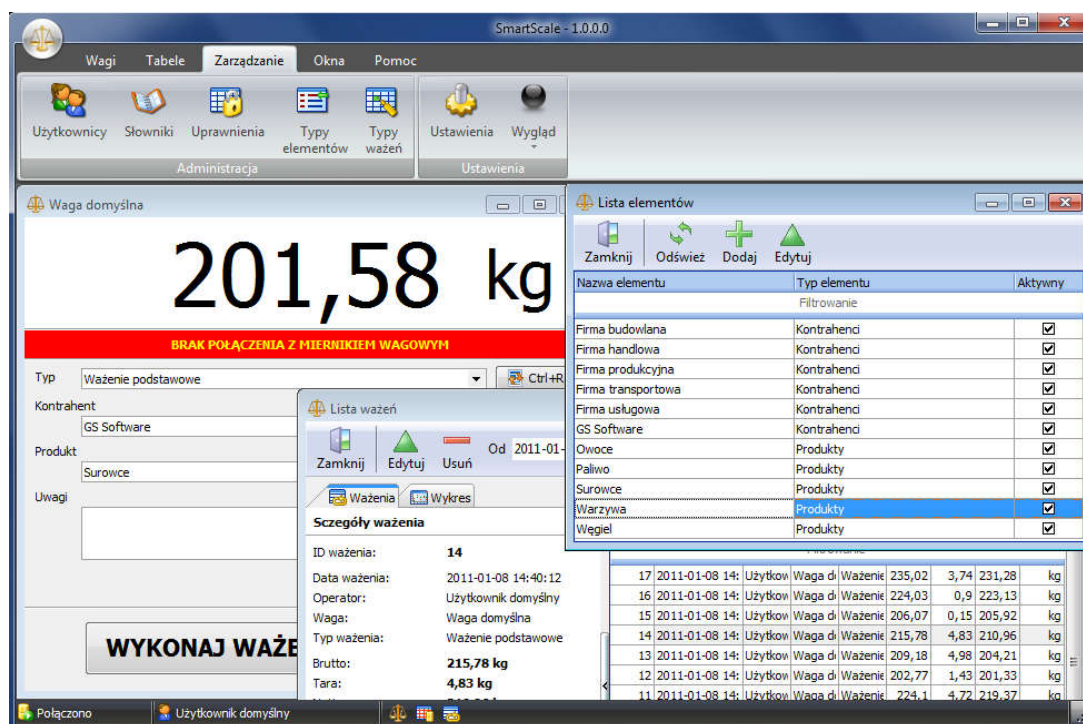

View of the main window

Depending on the configuration following option possible :

- Adjustment of customer-specific data
- Admin data managing
- User managing
- Export to TXT, CSV, RTF, JPG, XLS file
- Print out
- Label printing

Software comes with a USB flash drive activation key.

system Requirements:

Minimum requirements:

- hardware – Processor Intel Pentium 4, 512 MB RAM, 100 MB of the hard drive free;
- software: Windows 2000 (SP4), XP (SP2), Vista, Win7

Depending on version of KPZ Smart Scale , the following functionality is possible:

Function	Programm version		
	Standard	Professional	Premium
Facility to connect only one scale indicator	X		
Facility to connect any number of indicators the same time		X	X
Handling any model of KPZ indicator	X	X	X
Access to weighing list data window	X	X	X
Export weighing list data to the .TXT or .CSV file	X	X	X
Export weighing list data to the .XLS file(installation of MS Excel not necessary)		X	X
Weighing list data overview on the chart	X	X	X
Save the chart (weighing list data) as a picture	X	X	X
Weighing search	X	X	X
Weighing ticket preview	X	X	X
Save weighing ticket as PDF file	X	X	X
Edit data assigned to the weighing	X	X	X
History of weighing changes preview			X
Access to the Report Generator		X	X
Generating report to any data		X	X
Save the report as .PDF file		X	X
Export report data to .RTF, .CSV, .JPEG, XLS file (installation of MS Excel is necessary)		X	X
Export report data to . XLS file (installation of MS Excel not necessary)			X
Using programm as default user (with out Log in-Panel)	X		
Using programm as defined User or Admin		X	X
User Authorization Management			X
Facility to perform weighing without additional data	X	X	X
Facility to perform weighing with additional data: contractor, product, comments,	X	X	X
Facility to perform weighing with additional data: contractor, product, comments, + 2 additional dictionaries, + 2 additional text fields		X	X
Facility to perform weighting with any data type. Possibility to build any data structure.			X
Access to the window allowing to create dictionaries in a database			X
Network version		X	X
Print out as graphic or text mode	X	X	X
Facility to print out the logo on the ticket weighting (graphic mode)	X	X	X
Facility to create license data (one set only)	X		
Facility to create any number of license data set		X	X
Virtual Scales mechanism (planned)		X	X
Label ticket operation (planned)		X	X
Multi-language	X	X	X

Printers for KPZ scales

More printers and options on request!

Thermal printer Favorit 24	
Dimensions	85 x 85,5 mm (B x H)
Own weight	150 g
Power supply	Scale's battery
Interface	serial RS232
Version	Thermo-Direkt-Drucker, 203 dpi,
Paper	Paper width: 57 mm

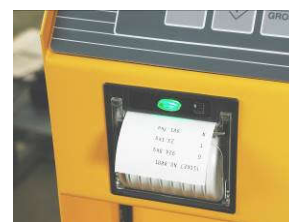

Ticket printer DR 2	
Dimensions	93x173x190 mm (B x H x T)
Own weight	1,2 kg
Power supply	230 VAC / 20 V DC 2,5 A
Interface	serial RS232, Parallel
Version	Thermo-Direkt-Drucker, 203 dpi,
Paper	Etiquette width : max 61mm



Ticket printer DR 6	
Dimensions	ca. 109 x 171 x 209 mm (B x H x T)
Own weight	ca. 1,2 kg
Power supply	100-240 VAC / 24 VDC 2,1 A
Interface	seriell RS232, Parallel
Version	Thermo-Direkt-Drucker, 203 dpi,
Paper	Etiquette width: 15-60mm



Thermal printer Favorit	
Dimensions	85 x 85,5 mm (B x H)
Own weight	150 g
Power supply	Scale's battery
Interface	serial RS232
Version	Thermo-Direkt-Drucker, 203 dpi,
Paper	Paper width: 57 mm



Rollerprinter DR 7	
Dimensions	110 x 125 x 70 mm (B x H x T)
Own weight	600 g
Power supply	230 VAC / 9 V DC 3,2 A
Interface	RS232, USB
Version	Thermo-Direkt
Paper	Papierbreite: 58mm, 20m, Ø40mm



Rollerprinter DR 7	
Dimensions	160 x 139 x 248 mm (B x H x T)
Own weight	2,3 kg
Power supply	230 VAC / 20 V DC 2,5 A
Interface	serial RS232, Parallel
Version	9- Needle printer, alphanumerischer Ausdruck
Paper	Paper width: 76 , 69,5 or 57,5 mm max. 40 digits on column



K-PZ Waagen
Kanalsteck 9
21129 Hamburg
Tel. 040 / 742174-0
Fax 040 / 742174-99
TICKET NO. 1
Art.-Nr.: 123456
PCS 40
APW 100 g
G 5.001 kg
T 1.000 kg
N 4.001 kg



KPZ 719SJDR
Exemplary formats
Indikátor KPZ 52 19



TICKET NO.0001
GS 124.5 kg
TR 20.0 kg
NT 104.5 kg

TICKET NO.0002
GS 124.0 kg
TR 20.0 kg
NT 104.0 kg

TOTAL NUMBER
OF TICKETS 0002
TOTAL WEIGHT
248.5 kg

Indicator KPZ 5218



23/08/2016, 16:42:45

TICKET NO.0001
G 2.0kg
T 0.0kg
N 2.0kg

23/08/2016, 16:43:01

TICKET NO.0002
G 5.6kg
T 0.0kg
N 5.6kg

23/08/2016, 16:43:13

TOTAL NUMBER
OF TICKETS 0002
TOTAL
NET 7.6kg

KPZ printers

Exemplary formats / Indicator KPZ 52(E) – 7 / Indicator KPZ 52(E) - 8

Examples are standard formats to printers KPZ. Possibility computer formats. Possibility of formats on customer request!

Exemplary print out Simple format 3	
S/N	WT/kg
0001	100,0
0002	200,0
0003	300,0
0003	600,0

Exemplary print out Complete format 4	
TICKET NO.0001	
G	100,0g
T	0,0g
N	100,0g
TICKET NO.0002	
G	200,0g
T	0,0g
N	200,0g
TICKET NO.0003	
G	300,0g
T	0,0g
N	300,0g
TOTAL NUMBER OF TICKETS 0003	
TOTAL	
NET	600,0g

G = Gross
T = Tare
N = Netto

Exemplary print out Stable format 5	
S/N	WT/kg
0001	100,0
0002	200,0
0003	300,0
0003	600,0

KPZ printers

Exemplary formats / Indicator KPZ 56-3/ KPZ 56-4 / KPZ 2-04-7 scale

Examples are the standard formats. Other formats are possible on request.

Example - format 1:

20.000	kg
7.975	kg
12.125	kg
13.380	kg

Example - format 2:

Ticket NO.	1	
Q'TY	40	PCS
APW	100	g
G/B	5.000	kg
T	1.000	kg
N	4.000	kg

Ticket NO.	2	
Q'TY	290	PCS
APW	100	g
G/B	30.000	kg
T	1.000	kg
N	29.000	kg

TOTAL TICKETS:	2
TOTAL Q'TY:	330 PCS

Example - format 3:

Date:	03-03-00	
Time:	09:04:43	
ID#:	123456789012345	
Part#:	543210987654321	
Ticket NO.	1	
Q'TY	40	PCS
APW	100	g
G/B	5.000	kg
T	1.000	kg
N	4.000	kg

Date:	03-03-00	
Time:	09:04:43	
ID#:	123456789012345	
Part#:	543210987654321	
Ticket NO.	2	
Q'TY	290	PCS
APW	100	g
G/B	30.000	kg
T	1.000	kg
N	29.000	kg

TOTAL TICKETS:	2
TOTAL Q'TY:	330 PCS

Example - format 4:

S/N	WT/kg	PCS
1.	20.000	3333
2.	20.000	3333
3.	8.000	1333
3/	TOTAL	Q'TY:
	7999	PCS

Example - format 5:

Date:	03-03-00	
Time:	09:04:43	
ID#:	123456789012345	
Part#:	543210987654321	
S/N	WT/kg	PCS
1.	20.000	3333
2.	20.000	3333
3.	8.000	1333
3/	TOTAL	Q'TY:
	7999	PCS

Printing formats

Indicator KPZ 56E-3 / KPZ 56E-4

Scale KPZ 2-04E-7

inkl. PT and Addition

Indicator KPZ 51E-9-2

standard format

NO.	1
G	276.7 kg
T	104.5 kg
PT	22.2 kg
N	150.0 kg
U/W	12 kg
PCS	13 pcs

NO.	2
G	176.7 kg
T	104.5 kg
PT	22.2 kg
N	50.0 kg
U/W	12 kg
PCS	4 pcs

=====	
T/N	2
T/W	200.0 kg
T/A	17 pcs

PT = Pretare

U/W = Unit Weight
PCS = Quantity

T/N = Total weighings
T/W= Total Netto weight
T/A= Total quantity

Example - format 1:

DATE:	03/03/2000
TIME:	09:04:43
TICKET NO.	01
NET:	+ 4.500 kg
GROSS:	+ 6.000 kg
TARE:	+ 1.000 kg
PRETARE:	+ 0.500 kg

DATE:	03/03/2000
TIME:	09:04:55
TICKET NO.	02
NET:	+ 5.500 kg
GROSS:	+ 6.000 kg
TARE:	+ 0.000 kg
PRETARE:	+ 0.500 kg

DATE:	03/03/2000
TIME:	09:05:35
TOTAL NO.	02
TOTAL NET:	+ 5.500 kg



KPZ 2-11-3 



KPZ 2-02-4 





KPZ 2-03-10  IP 65



KPZ 2-04-7 



KPZ 2E-06S  



KPZ 2114



KPZ 2082 Dual counting System



KPZ 1  



KPZ 1 B 



KPZ 2B 



KPZ 2S 



KPZ 2ECO 



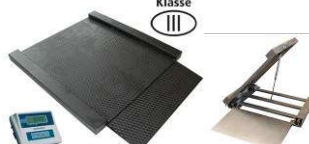

Low Construction Scale



KPZ 2D  



KPZ 71-*  

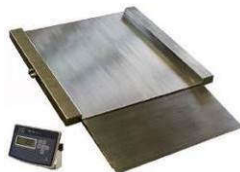

Stainless Steel DIN 1.4301, extrem solid and stable construction, IP 67, 68 and 69K



KPZ 72  



KPZ 73B



KPZ 73SDJ



KPZ 73 



KPZ 74 



KPZ 70  weighing Forks



KPZ 39
 Hydraulic Forklift scale



Crane scale 



Coil Scale



Animal scale 



Silo weighing





KPZ PC Software



Special models are our speciality!

Mobile KPZ scales



KPZ 71-7   
 Many Option possible



Option **KPZ 71-7**



KPZ 71-8 
 2.200kg / 200g



KPZ 71-9
 2.200kg / 500g



KPZ 72 



KPZ 72, 2400mm, 3200kg



KPZ 73 



KPZ 73 SDJ 



KPZ 73 B 



KPZ 74 



Weighing forks Forklift truck scale



KPZ 39
 Electronic – Hydraulic version



Touch sreen Indicator 7-Zoll



Scale for Coil's



German design and own EU production guarantees high quality.

Stainless steel Material : DIN 1.4301 / 1.4541 / 1.4404

KPZ-Waagen, Stainless steel scale and Indicator, IP 67/68/69K



Platform Scale KPZ 2N, Stainless steel, IP 67/68/69 K

Stainless steel Material : DIN 1.4301 / 1.4541 / 1.4404

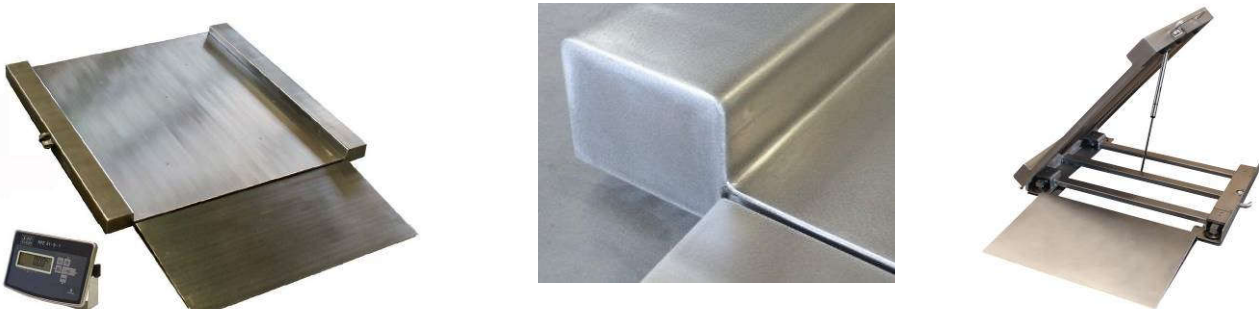

Low construction scale KPZ 2DN

Plain, top plate of platform made of one piece. IP 67/68/69K

Stainless steel Material : DIN 1.4301 / 1.4541 / 1.4404



**Pallet weigher Type: KPZ 71-7N
stainless steel DIN 1.430, IP 67/68/69K**

**Pallet scale KPZ 1N, IP 67/68/69K
Stainless steel - Material 1.4301**



**Bench Scale KPZ 2E-06, stainless steel DIN 1.430, IP 67/68, IP 69K
German design and own EU production guarantees high quality.**

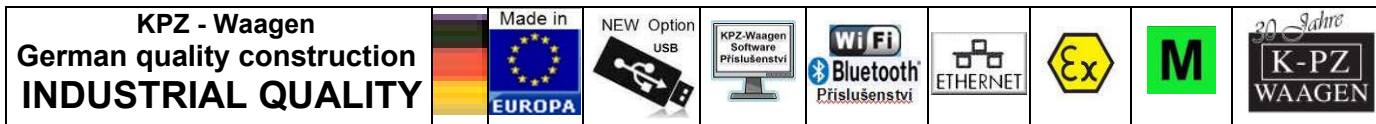

200206 00 BR UK €



KPZ - Váhy, s. r. o.

**Libošovice 76,
CZ 507 44 Libošovice**

Tel.:

+420 736 622 710

+420 493 571 111

email: kpz@kpz-vahy.cz / zander@kpzwaagen.de

www.kpzwaagen.com