

KPZ 1S | Pallet scales

Solid Pallet scale for industrial use | Capacity: up to 15.000kg
Weights & measures | powder coating | good value for money | solid

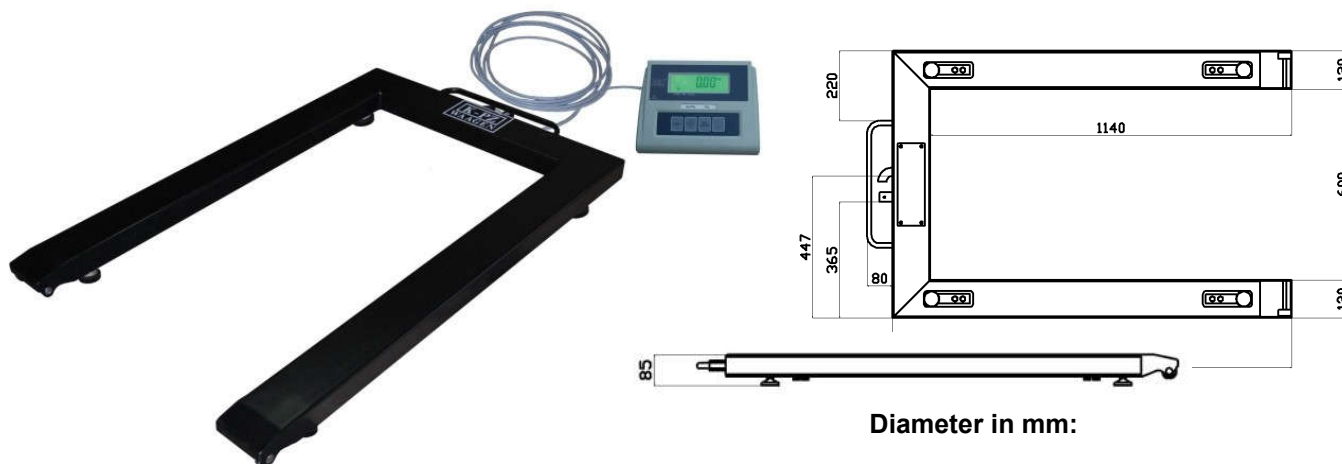

Type	Capacity	Division	Indicator	Dim. mm	Approval possible	Article-No.
KPZ 1E	600 kg	200 g	KPZ 52E-8	840 x 1260	YES	1S00000060E
KPZ 1EM	600/1200 kg	200/500 g	KPZ 52E-8	840 x 1260	YES	1SM00000120E
KPZ 1M	600/1200 kg	200/500 g	KPZ 52-18	840 x 1260	No	1SM000001200
KPZ 1E	1500 kg	500 g	KPZ 52E-8	840 x 1260	YES	1S000000150E
KPZ 1	1500 kg	500 g	KPZ 52-18	840 x 1260	No	1S0000001500
KPZ 1E	2000 kg	1000 g	KPZ 52E-8	840 x 1260	YES	1S000000200E
KPZ 1	2000 kg	1000 g	KPZ 52-18	840 x 1260	No	1S0000002000
KPZ 1M	1000/2000 kg	200/500 g	KPZ 52-18	840 x 1260	No	1SM000002000
KPZ 1EM	1500/3000 kg	500/1000 g	KPZ 52E-8	840 x 1260	YES	1SM00000300E
KPZ 1M	1500/3000 kg	500/1000 g	KPZ 52-18	840 x 1260	No	1SM000003000
KPZ 1E	3000 kg	1000 g	KPZ 52E-8	840 x 1260	YES	1S000000300E
KPZ 1	3000 kg	1000 g	KPZ 52-18	840 x 1260	No	1S0000003000
KPZ 1M	3000/6000 kg	1000 /2000 g	KPZ 52-18	840 x 1260	No	1SM000006000
KPZ 1E	6000 kg	2000 g	KPZ 52E-8	840 x 1260	YES	1S000000600E
KPZ 1JE	1500/3000 kg	500/1000 g	KPZ 52E8	1000 x 1260	Ano	1SJ0000300EL
KPZ 1SM	1500/3000 kg	500/1000 g	KPZ 5218	1000 x 1260	Ne	1SJM0000300L
KPZ 1M	3000 kg	1000 g	KPZ 5218	1000 x 1260	Ne	1SM00000300L
KPZ 1E	3000 kg	1000 g	KPZ 52E8	1000 x 1260	Ano	1S000000300E

Solid and stable platform scales series KPZ 1S. **German design and own EU production guarantees high quality.** Designed as floor scales, industrial weighing. High accuracy. Maintenance-free durable steel construction. Powder paint coated. **Construction:** Robust, maintenance-free, welded steel construction, heavy duty design for industrial use, non-slip finish weighing platform, durable black powder coat. **Load cells:** Robust, nickel-plated load cell, IP68, OIML, with a high overload capacity. **Levelling feet.** **Installation:** Adjustable leveling feet, designed for permanent or portable installations, 5m cable to connect digital indicator. **Options:** Extra ramps, Base anchors, Wall mounting for indicator, Indicator stand, Custom sizes and capacities. **Standard indicator:** KPZ 52-18, **For approved applications:** KPZ 52E-8, **Options for indicators:** Multi range, RS 232 serial interface, Various printers connection, Radio data transfer, WLAN, etc.. Internal battery. **Approvals:** OIML class III , CE conform. **Power Supply :** 230 V mains, Power cord

Special requirements for unique loading - please contact us for more information!

KPZ price includes complete scale with indicator.

Special models are our speciality!



Floor Scale

 KPZ 1SX / 	 KPZ 1S / 	 KPZ 1BS / 
 KPZ 2SX / 	 KPZ 2S / 	 KPZ 2ECO / 
 KPZ 2B / 	 KPZ 2D / 	 KPZ 2 D  
 KPZ 2-08-2 Dual Counting System 	 KPZ 2ECOW / laundry scale 	 KPZ 2E07 
 KPZ 2A, 220x92x160cm, 1500kg Div. 500g 	 Animal Scale	
 aluminum+Stainless construction	 Pig Scale 300kg, 100g	 VET Scale

Container scale

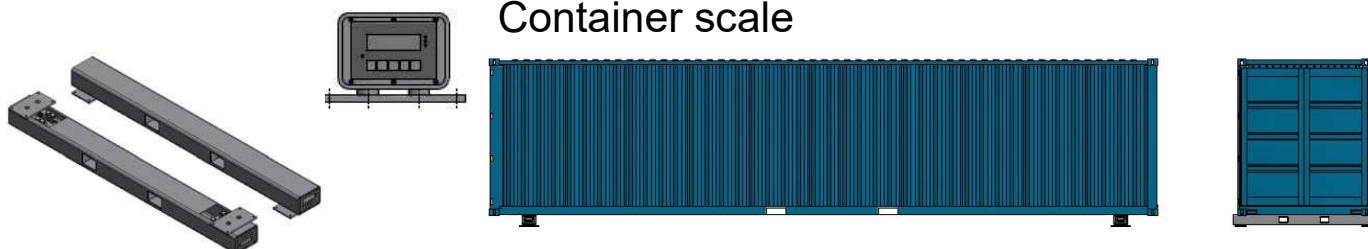

German design and own EU production guarantees high quality.

KPZ-Váhy s.r.o. • Libošovice 76 • CZ507 44 Libošovice • GSM: 00420736622710 • Email: zander@kpzwaagen.de •
KPZ-Waagen - 30years - AFFORDABLE, ROBUST and GOOD !! www.kpzwaagen.com





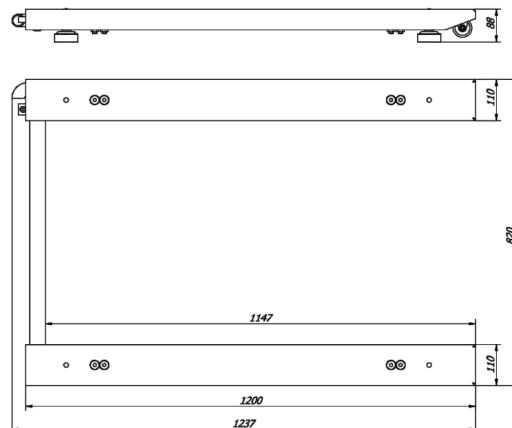

We reserve the right to make technical modifications and price changes without prior notification. Warranty: The parts and components are warranted for **two years** from the date of delivery against defects in materials and workmanship, provided proper and normal use condition, excluding batteries and chargers.

KPZ 1SX / Pallet scales

Solid Pallet scale for industrial use

Weights & measures | powder coating | good value for money | solid



Type	Capacity kg	Division g	Indicator	Dim. mm	Approval possible	Article-No.
KPZ 1SXE	300 kg	100 g	KPZ 52E-8	820 x 1200	YES 	1SX00000030E
KPZ 1SX	300 kg	100 g	KPZ 5218	820 x 1200	NO	1SX000000300
KPZ 1SXE	600 kg	200 g.	KPZ 52E-8	820 x 1200	YES 	1SX00000060E
KPZ 1SX	600 kg	200 g.	KPZ 5218	820 x 1200	NO	1SX000000600
1SXE	1500 kg	500 g	KPZ 52E-8	820 x 1200	YES 	1SX00000150E
1SX	1500 kg	500 g	KPZ 5218	820 x 1200	NO	1SX000001500
1SXE	2000 kg	1000 g	KPZ 52E-8	820 x 1200	YES 	1SX00002000E
1SX	2000 kg	1000 g	KPZ 5218	820 x 1200	NO	1SX000020000
KPZ 1M	1000/2000	200/500	without	820 x 1200	NO	1XM000020oA
KPZ1SXE	1500 kg	500 g	KPZ 52E-8	1000x1200x85	YES 	1SX00101500E
KPZ1SXE	2000 kg	1.000 g	KPZ 52E-8	1000x1200x85	YES 	1SX00102000E
KPZ1SXE	2000 kg	1.000 g	without	1000x1200x85	YES 	1SX0001020oA

*Option : Corner calibration

Solid and stable platform scales series KPZ 1S. **German design and own EU production guarantees high quality.** Designed as floor scales, industrial weighing. High accuracy. Maintenance-free durable steel construction. Powder paint coated.

Construction: Robust, maintenance-free, welded steel construction, heavy duty design for industrial use, non-slip finish weighing platform, durable black powder coat. **Load cells:** Robust, nickel-plated load cell, IP68, OIML, with a high overload capacity. **Levelling feet.** **Installation:** Adjustable leveling feet, designed for permanent or portable installations, 5m cable to connect digital indicator. **Options:** Extra ramps, Base anchors, Wall mounting for indicator, Indicator stand, Custom sizes and capacities.

Standard indicator: KPZ 52-18, **For approved applications:** KPZ 52E-8, **Options for indicators:** Multi range, RS 232 serial interface, Various printers connection, Radio data transfer, WLAN, etc.. Internal battery. **Approvals:** OIML class III , CE conform. **Power Supply** : 230 V mains, Power cord

Special requirements for unique loading - please contact us for more information!

KPZ price includes complete scale with indicator.

German design and own EU production guarantees high quality.

Special models are our speciality!



KPZ 1S | Pallet scales

Solid Pallet scale for industrial use | Capacity: up to 15.000kg
Weights & measures | powder coating | good value for money | solid

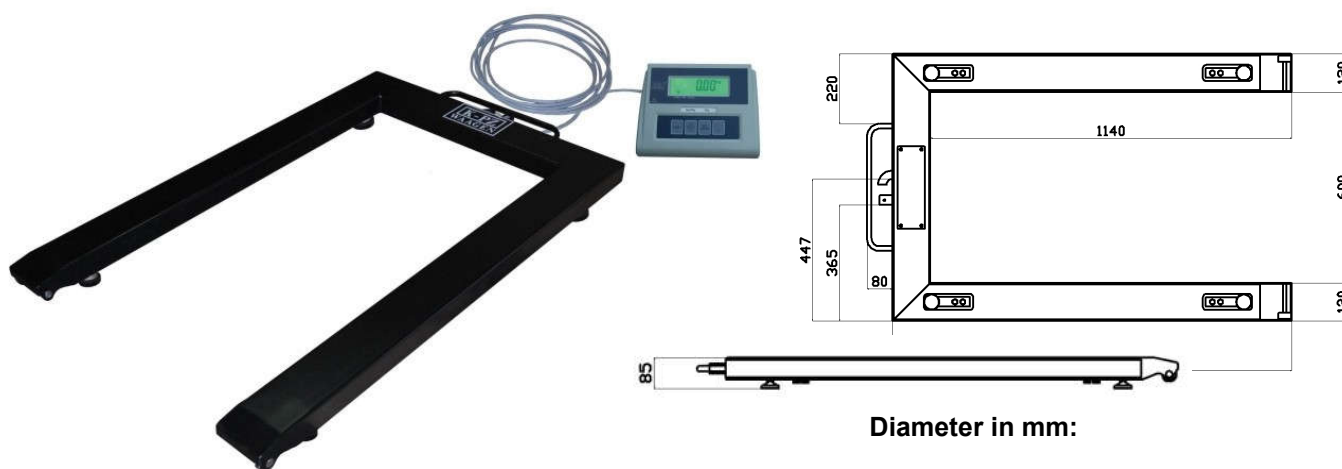

Diameter in mm:

Type	Capacity	Division	Indicator	Dim. mm	Approval possible	Article-No.
KPZ 1E	600 kg	200 g	KPZ 52E-8	840 x 1260	YES	1S00000060E
KPZ 1EM	600/1200 kg	200/500 g	KPZ 52E-8	840 x 1260	YES	1SM00000120E
KPZ 1M	600/1200 kg	200/500 g	KPZ 52-18	840 x 1260	No	1SM000001200
KPZ 1E	1500 kg	500 g	KPZ 52E-8	840 x 1260	YES	1S000000150E
KPZ 1	1500 kg	500 g	KPZ 52-18	840 x 1260	No	1S0000001500
KPZ 1E	2000 kg	1000 g	KPZ 52E-8	840 x 1260	YES	1S000000200E
KPZ 1	2000 kg	1000 g	KPZ 52-18	840 x 1260	No	1S0000002000
KPZ 1M	1000/2000 kg	200/500 g	KPZ 52-18	840 x 1260	No	1SM000002000
KPZ 1EM	1500/3000 kg	500/1000 g	KPZ 52E-8	840 x 1260	YES	1SM00000300E
KPZ 1M	1500/3000 kg	500/1000 g	KPZ 52-18	840 x 1260	No	1SM000003000
KPZ 1E	3000 kg	1000 g	KPZ 52E-8	840 x 1260	YES	1S000000300E
KPZ 1	3000 kg	1000 g	KPZ 52-18	840 x 1260	No	1S0000003000
KPZ 1M	3000/6000 kg	1000 /2000 g	KPZ 52-18	840 x 1260	No	1SM000006000
KPZ 1E	6000 kg	2000 g	KPZ 52E-8	840 x 1260	YES	1S000000600E
KPZ 1JE	1500/3000 kg	500/1000 g	KPZ 52E8	1000 x 1260	Ano	1SJ0000300EL
KPZ 1SM	1500/3000 kg	500/1000 g	KPZ 5218	1000 x 1260	Ne	1SJM0000300L
KPZ 1M	3000 kg	1000 g	KPZ 5218	1000 x 1260	Ne	1SM00000300L
KPZ 1E	3000 kg	1000 g	KPZ 52E8	1000 x 1260	Ano	1S000000300E

Solid and stable platform scales series KPZ 1S. **German design and own EU production guarantees high quality.** Designed as floor scales, industrial weighing. High accuracy. Maintenance-free durable steel construction. Powder paint coated. **Construction:** Robust, maintenance-free, welded steel construction, heavy duty design for industrial use, non-slip finish weighing platform, durable black powder coat. **Load cells:** Robust, nickel-plated load cell, IP68, OIML, with a high overload capacity. **Levelling feet.** **Installation:** Adjustable leveling feet, designed for permanent or portable installations, 5m cable to connect digital indicator. **Options:** Extra ramps, Base anchors, Wall mounting for indicator, Indicator stand, Custom sizes and capacities. **Standard indicator:** KPZ 52-18, **For approved applications:** KPZ 52E-8, **Options for indicators:** Multi range, RS 232 serial interface, Various printers connection, Radio data transfer, WLAN, etc.. Internal battery. **Approvals:** OIML class III , CE conform. **Power Supply :** 230 V mains, Power cord

Special requirements for unique loading - please contact us for more information!

KPZ price includes complete scale with indicator.

Special models are our speciality!



KPZ 1BSX | Beam scale

Solid Pallet scale for industrial use | Capacity : up to 2.000kg



Inexpensive version



Fixing Clamps for fixed attachment to the beam. Available in a set of 4 or 6 pieces.

Type	Capacity	Division	Indicator	Dim. mm	Possible	Art-Nr.
KPZ 1BSXM	1000/2000 kg	500/1000 g	without	85 x 1000	Yes	1BXM00102000
KPZ 1BSXM	1000/2000 kg	500/1000 g	without	85 x 1200	Yes	1BXM00122000
KPZ 1BSXM	1000/2000 kg	500/1000 g	without	85 x 1500	Yes	1BXM00152000
KPZ 1BSXM	1000/2000 kg	500/1000 g	KPZ 52-18	85 x 1000	No	1BSXM0102000
KPZ 1BSXE	1500 kg	500 g	KPZ 52E-8	85 x 1000	Yes	1BSX0010150E
KPZ 1BSX	1500 kg	500 g	KPZ 52-18	85 x 1000	No	1BSX00101500
KPZ 1BSXE	2000 kg	1000 g	KPZ 52E-8	85 x 1000	Yes	1BSX0010200E
KPZ 1BSX	2000 kg	1000 g	KPZ 52-18	85 x 1000	No	1BSX00102000
KPZ 1BSXM	1000/2000 kg	500/1000 g	KPZ 52-18	85 x 1200	No	1BSXM0122000
KPZ 1BSXE	1500 kg	500 g	KPZ 52E-8	85 x 1200	Yes	1BSX0012150E
KPZ 1BSX	1500 kg	500 g	KPZ 52-18	85 x 1200	No	1BSX00121500
KPZ 1BSXE	2000 kg	1000 g	KPZ 52E-8	85 x 1200	Yes	1BSX0012200E
KPZ 1BSX	2000 kg	1000 g	KPZ 52-18	85 x 1200	No	1BSX00122000
KPZ 1BSXM	1000/2000 kg	500/1000 g	KPZ 52-18	85 x 1500	No	1BSXM0152000
KPZ 1BSXE	1500 kg	500 g	KPZ 52E-8	85 x 1500	Yes	1BSX0015150E
KPZ 1BSX	1500 kg	500 g	KPZ 52-18	85 x 1500	No	1BSX00151500
KPZ 1BSXE	2000 kg	1000 g	KPZ 52E-8	85 x 1500	Yes	1BSX0015200E
KPZ 1BSX	2000 kg	1000 g	KPZ 52-18	85 x 1500	No	1BSX00152000
Fixing clamps for KPZ 1B for 85mm profile, 4 pieces						1B000000100
Fixing clamps for KPZ 1B for 85mm profile, 6 pieces						1B000000200

Solid and stable scales series KPZ 1BSX. **German design and own EU production guarantees high quality.**

Designed as floor scales, industrial weighing. High accuracy. Maintenance-free durable steel construction. Powder paint coated.

Construction: Robust, maintenance-free, welded steel construction, heavy duty design for industrial use, durable black powder coat. **Load cells:** Robust, nickel-plated load cell, IP68, OIML, with a high overload capacity.

Levelling feet. Installation: Adjustable leveling feet, designed for permanent or portable installations, 5m cable to connect digital indicator. **Options:** Base anchors, Wall mounting for indicator, Indicator stand, Custom sizes and capacities

Standard indicator: KPZ 52-18, **For approved applications:** KPZ 52E-8, **Options for indicators:** Multi range, RS 232 serial interface, Various printers connection, Radio data transfer, WLAN, etc.. Internal battery.

Approvals: OIML class III , CE conform. **Power Supply** : 230 V mains, Power cord

... please contact us for special requests!

Special models are our speciality!

German design and own EU production guarantees high quality.



KPZ 1B | Beam scale | Capacity : up to 50.000kg Solid, heavy duty design Pallet scale for strong industrial use

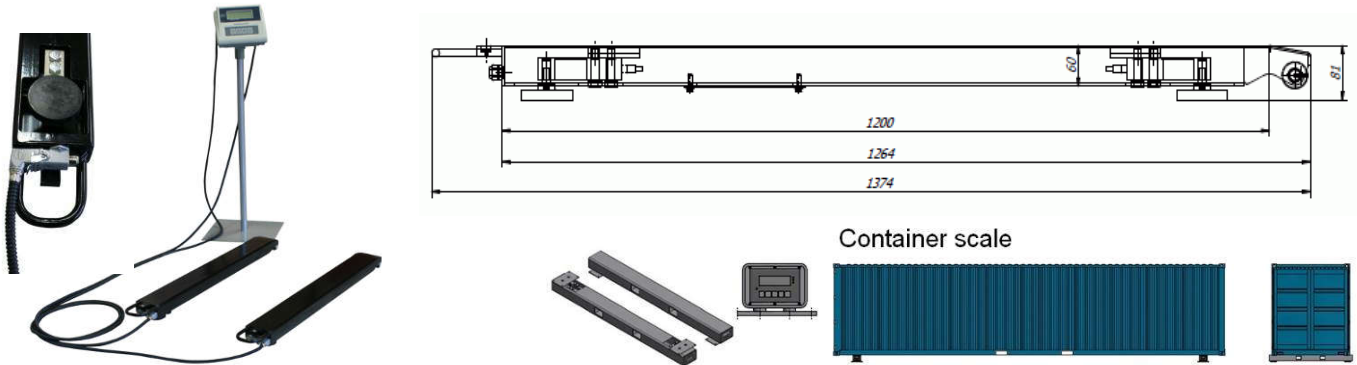

Type	Capacity	Div.	Indicator	Dim. /mm	possible	Art-Nr.
KPZ 1BSM	1500/3000 kg	500/1000 g	KPZ 52-18	85 x 800	No	1BSM00083000
KPZ 1BSE	1500 kg	500 g	KPZ 52E-8	85 x 800	Yes	1BS00008150E
KPZ 1BS	1500 kg	500 g	KPZ 52-18	85 x 800	No	1BS000081500
KPZ 1BSE	3000 kg	1000 g	KPZ 52E-8	85 x 800	Yes	1BS00008300E
KPZ 1BS	3000 kg	1000 g	KPZ 52-18	85 x 800	No	1BS000083000
KPZ 1BSM	1500/3000 kg	500/1000 g	KPZ 52-18	85 x 1000	No	1BSM00103000
KPZ 1BSE	1500 kg	500 g	KPZ 52E-8	85 x 1000	Yes	1BS00010150E
KPZ 1BS	1500 kg	500 g	KPZ 52-18	85 x 1000	No	1BS000101500
KPZ 1BSE	3000 kg	1000 g	KPZ 52E-8	85 x 1000	Yes	1BS00010300E
KPZ 1BS	3000 kg	1000 g	KPZ 52-18	85 x 1000	No	1BS000103000
KPZ 1BSM	1500/3000 kg	500/1000 g	KPZ 52-18	85 x 1200	No	1BSM00123000
KPZ 1BSE	1500 kg	500 g	KPZ 52E-8	85 x 1200	Yes	1BS00012150E
KPZ 1BS	1500 kg	500 g	KPZ 52-18	85 x 1200	No	1BS000121500
KPZ 1BSE	3000 kg	1000 g	KPZ 52E-8	85 x 1200	Yes	1BS00012300E
KPZ 1BS	3000 kg	1000 g	KPZ 52-18	85 x 1200	No	1BS000123000
KPZ 1BSM	1500/3000 kg	500/1000 g	KPZ 52-18	85 x 1500	No	1BSM00153000
KPZ 1BSE	1500 kg	500 g	KPZ 52E-8	85 x 1500	Yes	1BS00015150E
KPZ 1BS	1500 kg	500 g	KPZ 52-18	85 x 1500	No	1BS000151500
KPZ 1BSE	3000 kg	1000 g	KPZ 52E-8	85 x 1500	Yes	1BS00015300E
KPZ 1BS	3000 kg	1000 g	KPZ 52-18	85 x 1500	No	1BS000153000

KPZ price includes complete scale with indicator.

Solid and stable scales series KPZ 1B. **German design and own EU production guarantees high quality.** Designed as floor scales, industrial weighing. High accuracy. Maintenance-free durable steel construction. Powder paint coated.

Construction: Robust, maintenance-free, welded steel construction, heavy duty design for industrial use, durable black powder coat. **Load cells:** Robust, nickel-plated load cell, IP68, OIML, with a high overload capacity. **Levelling feet.** **Installation:** Adjustable leveling feet, designed for permanent or portable installations, 5m cable to connect digital indicator. **Options:** Base anchors, Wall mounting for indicator, Indicator stand, Custom sizes and capacities

Standard indicator: KPZ 52-18, **For approved applications:** KPZ 52E-8, **Options for indicators:** Multi range, RS 232 serial interface, Various printers connection, Radio data transfer, WLAN, etc. **Internal battery Approvals:** OIML class III , CE conform. **Power Supply :** 230 V mains, Power cord

German design and own EU production guarantees high quality.

Weights & measures | powder coating | good value for money | solid

Special models are our speciality!



KPZ 2SCM / Platform scale

Solid floor scales up to 3.000 kg for industrial use

Weights & measures | powder coating | good value for money | solid



Stativ as Option



Solid and stable platform scales series KPZ 2SC. German design and own EU production guarantees high quality. Designed as floor scales, for industrial weighing. High accuracy.

Maintenance-free durable steel construction. Black powder paint coated. **Load cells:** 4 high quality, OIML approved C 3, DMS load cell, IP 68, type KPZ 502E-2/3. **Certification:** approved for retail use and NON approved Version, CE - conform. **Multirange Division :** 0 kg to 1.500kg, Division: 500g | 1.500kg to 3.000kg, Division: 1.000g. **Indicator :** KPZ 52(E)16-1 included the Price, with 5m Cable between Platform and Indicator. **KPZ 51(E)-16-1** indicator, build in robust ABS housing , 6-digit 25 mm high backlite LCD display with status symbols, large using keys, separate ON switch. **Wallmounting.** **Basic function:** zero setting, tare (multitare possible) minus indication, switching net/gross, Over menu **adjustable:** Set point or limit value control. **LED display:** zero setting, tare, stability, battery charging status, LOW- Bat indication. **Power supply:** rechargeable battery, adapter 230 VAC (incl.the price). **Connection:** serial interface RS232, included. **Certification :** EU type approval certificate class III, CE conform.

KPZ price includes : complete scale with indicator, built-in rechargeable battery and RS 232, KPZ price includes : by KPZ 2SCME also the Factory first Certification.

Typ	Cap, kg	Div. g	Dim. mm	Approved possible	Indicator	Art.-No.
KPZ 2 SCM	1500/3000	500/1000	1000 x1000		without	2SCM101030OH
KPZ 2 SCM	1500/3000	500/1000	1000 x1000	No	KPZ 52 16-1	2SCM10103000
KPZ 2 SCME	1500/3000	500/1000	1000 x1000	YES	KPZ 52E16-1	2SCM1010300E
KPZ 2 SCM	1500/3000	500/1000	1000 x1250		without	2SCM121530OH
KPZ 2 SCM	1500/3000	500/1000	1000 x1250	No	KPZ 52 16-1	2SCM12153000
KPZ 2 SCME	1500/3000	500/1000	1000 x1250	YES	KPZ 52E16-1	2SCM1215300E
KPZ 2 SCM	1500/3000	500/1000	1250 x1250		without	2SCM121230OH
KPZ 2 SCM	1500/3000	500/1000	1250 x1250	No	KPZ 52 16-1	2SCM12123000
KPZ 2 SCME	1500/3000	500/1000	1250 x1250	YES	KPZ 52E16-1	2SCM1212300E
KPZ 2 SCM	1500/3000	500/1000	1250 x1500		without	2SCM121230OH
KPZ 2 SCM	1500/3000	500/1000	1250 x1500	No	KPZ 52 16-1	2SCM12123000
KPZ 2 SCME	1500/3000	500/1000	1250 x1500	YES	KPZ 52E16-1	2SCM1215300E
KPZ 2 SCM	1500/3000	500/1000	1500 x1500		without	2SCM151530OH
KPZ 2 SCM	1500/3000	500/1000	1500 x1500	No	KPZ 52 16-1	2SCM15153000
KPZ 2 SCM	1500/3000	500/1000	1500 x1500	YES	KPZ 52E16-1	2SCM1515300E

Packing Dim. : 5 pcs / 100x100cm, 102x102x110cm. 425kg/ 1.25x1.25cm, 127x127x110cm. 500kg / 1,50x1,50cm : 152x152x110cm. Weight 600kg

.....pls contact us for special request !

German design and own EU production guarantees high quality.



KPZ 2SX / Platform scale
Solid floor scales up to 3.000 kg for industrial use
Weights & measures | powder coating | good value for money | solid

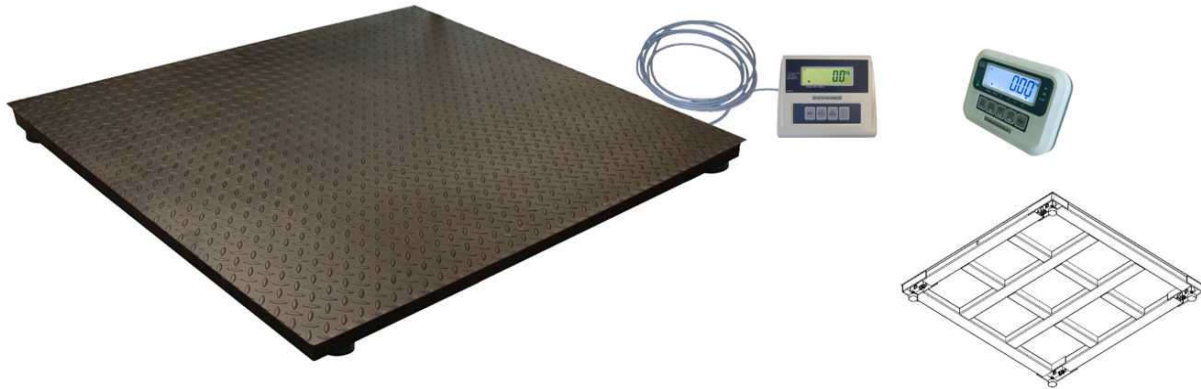

Solid and stable platform scales series KPZ 2SX. **German design and own EU production guarantees high quality.** Designed as floor scales, industrial weighing. High accuracy. Maintenance-free durable steel construction. Powder paint coated.

Construction: Robust, maintenance-free, welded steel construction, heavy duty design for industrial use, non-slip finish weighing platform, durable black powder coat. **Load cells:** Robust, nickel-plated load cell, IP68, OIML, with a high overload capacity. **Levelling feet.** **Installation:** Adjustable leveling feet, designed for permanent or portable installations, 5m cable to connect digital indicator. **Options:** Extra ramps, Base anchors, Wall mounting for indicator, Indicator stand, Custom sizes and capacities

Standard indicator: KPZ 52-18. **For approved applications:** KPZ 52E-8- **Options for indicators:** Multi range, RS 232 serial interface, Various printers connection, Radio data transfer, WLAN, etc.. Internal battery

Approvals: OIML class III , CE conform. **Power Supply** : 230 V mains, Power cord

Special requirements for unique loading - please contact us for more information!

Typ	Capacity	Division	Dim. mm	Approval possible	Indicator	Art.-Nr
KPZ 2X	1500/3000	500/1000	1000 x 1000 x 100	Ja	without	2SX010103000
KPZ 2X	1500/3000	500/1000	1000 x 1000 x 100	Nein	KPZ 5218	2SXM10103000
KPZ 2XE	3000	1000	1000 x 1000 x 100	Ja	KPZ 52E8	2SXE1010300E
KPZ 2XEM	1500/3000	500/1000	1000 x 1000 x 100	Ja	KPZ 52E8	2SXM1010300E
KPZ 2X	1500/3000	500/1000	1250 x 1250 x 100	Ja	without	2SX012123000
KPZ 2X	1500/3000	500/1000	1250 x 1250 x 100	Nein	KPZ 5218	2SXM12123000
KPZ 2XE	3000	1000	1250 x 1250 x 100	Ja	KPZ 52E8	2SXE1212300E
KPZ 2XEM	1500/3000	500/1000	1250 x 1250 x 100	Ja	KPZ 52E8	2SXM1212300E
KPZ 2X	1500/3000	500/1000	1250 x 1500 x 100	Ja	without	2SX012153000
KPZ 2X	1500/3000	500/1000	1250 x 1500 x 100	Nein	KPZ 5218	2SXM12153000
KPZ 2XE	3000	1000	1250 x 1500 x 100	Ja	KPZ 52E8	2SXE1215300E
KPZ 2XEM	1500/3000	500/1000	1250 x 1500 x 100	Ja	KPZ 52E8	2SXM1215300E
KPZ 2X	1500/3000	500/1000	1500 x 1500 x 100	Ja	without	2SX015153000
KPZ 2X	1500/3000	500/1000	1500 x 1500 x 100	Nein	KPZ 5218	2SXM15153000
KPZ 2XE	3000	1000	1500 x 1500 x 100	Ja	KPZ 52E8	2SXE1515300E
KPZ 2XEM	1500/3000	500/1000	1500 x 1500 x 100	Ja	KPZ 52E8	2SXM1515300E

***Option : Corner Adjustment**

Ramp for KPZ 2SX	Ramp dimension	Article-Nr
KPZ 2X, 1000 x 1000 mm up to 3t	1000 mm wide, 800 mm long	21SX08103000
KPZ 2X; 1250 x 1250 mm up to 3t	1250 mm wide, 800 mm long	21SX08123000
KPZ 2X, 1250 x 1500 mm up to 3t	1250 mm wide, 800 mm long	21SX08123000
KPZ 2X, 1500 x 1500 mm up to 3t	1500 mm wide, 800 mm long	21SX08153000

German design and own EU production guarantees high quality.

Special models are our speciality!

Weights & measures | powder coating | good value for money| solid

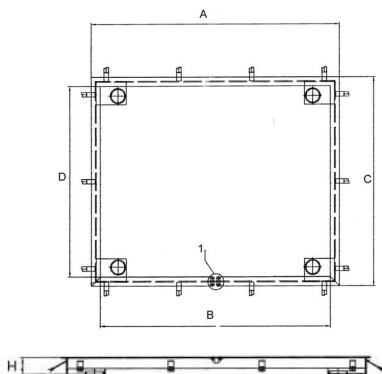

Pit frame for KPZ 2S, Div. mm:

Pit frame for KPZ 2t	A	B	C	D	H	Article No.
1000 x 1000 to 3000kg	1120	1020	1120	1020	120	25S010103000
1250 x 1250 to 3000kg	1370	1270	1370	1270	120	25S012123000
1250 x 1500 to 3000kg	1620	1520	1370	1270	120	25S012153000
1500 x 1500 o 3000kg	1620	1520	1620	1520	120	25S015153000

Výřez 1 na nákrese = Odnímatelný kryt otvoru pro průchod kabelu. Minimální velikost prostoru pro zapuštění = A+160mm x C+160mm

Safety Frame for KPZ 2, 1000 x 1000 mm, up to 3 t, 3 to 4 side	25SU10103040
Safety Frame for KPZ 2, 1250 x 1250 mm, up to 3 t, 3 to 4 side	25SU12123040
Safety Frame for KPZ 2, 1250 x 1500 mm, up to 3 t, 3 to 4 side	25SU12153040
Safety Frame for KPZ 2, 1500 x 1500 mm, up to 3 t, 3 to 4 side	25SU15153040

Packing dimension			
Model	Scale Cap.	Packing Dim.	Weight
KPZ 2 1000 x 1000	Up to 3000kg	120 x 100 x 40 cm, 100 kg	80 kg
KPZ 2 1250 x 1250	Up to 3000kg	125 x 125 x 40 cm 135 kg	115 kg
KPZ 2 1250 x 1500	Up to 3000kg	125 x 150 x 40 cm. 160 kg	130 kg
KPZ 2 1500 x 1500	Up to 3000kg	150 x 150 x 40 cm 180 kg	160 kg



Safety Frame for KPZ 2



Elevated frame

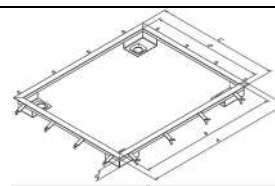

Pit Frame for KPZ 2,

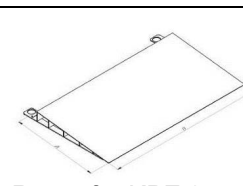

Ramp for KPZ 2

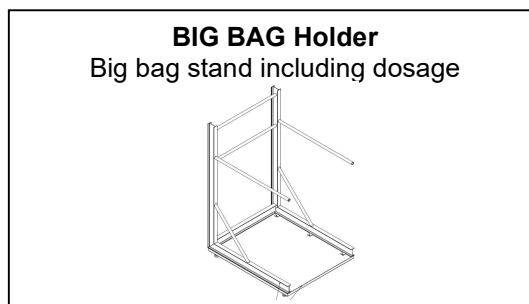

KPZ price includes complete scale with indicator.

Special requirements for unique loading - please contact us for more information!

Special models are our speciality!

German design and own EU production guarantees high quality.

KPZ 2S / Platform scale

Robust floor scale up to 20.000 kg for industrial use

Better quality: We use only EU approved components !!!

**Maintenance free
Long service life
Robust
Inexpensive
Mobile**

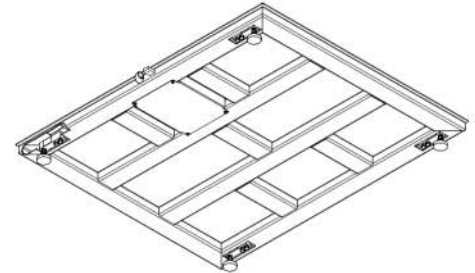







KPZ quality construction e.g.:
KPZ 2S : 1250x1500 mm

For continuous operation

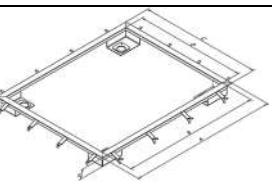
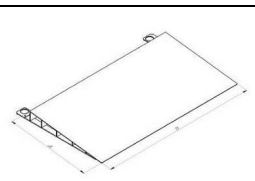

Options:

			
For beams	Pull up possibility	Hinged platform	Safety Frame for KPZ 2,
			
Forklift fork shoes	Elevated frame	Pit frame for KPZ 2 ,	Ramp for KPZ 2

Solid and stable platform scales series KPZ 2S. **German design and own EU production guarantees high quality.** Designed as floor scales, industrial weighing. High accuracy. Maintenance-free durable steel construction. Powder paint coated.

Platform scale KPZ 2, high quality industrial platform, long service life, solid and stable steel construction black powder painted, structured plate. **Load cells:** High quality load cells DMS type KPZ 502E-3, IP67, OIML C3.

Indicator: KPZ 52E-8 (possibility to deliver without indicator), 16ft cable, sheltered at way out of scale in case of mechanical damage. **Certification:** EC approval possibility class III, Declaration of Conformity.

Construction: steel, welded frame made of profile with diagonal reinforcement and solid structured plate, black powder painted (option: galvanized or stainless construction). Indicator connection cable: length 16ft. Special flat construction is suitable for ground placing. With regard to solid DMS load cells there are no wearing out parts.

Weighing system: 4 high quality DMS load cells KPZ 502E-3, IP67, EC approval possibility class III.

Approvals: OIML class III , CE conform. **Power Supply :** 230 V mains, Power cord

... please contact us for special requests!

Weighing range from 0 up to 20.000 kg

Weights & measures | powder coating | good value for money | solid

PZ - Waagen German quality construction INDUSTRIAL QUALITY									
	200305 00 N UK €								

Typ	Capacity	Division	Dim. mm	Approval possible	Indicator	Art.-Nr
KPZ 2JE	300 kg	100 g	800 x 800 x 95	YES	52E8	2SJ00808030E
KPZ 2JM	150/300 kg	50/100 g	800 x 800 x 95	No	5218	2SJM08080300
KPZ 2JE	600 kg	200 g	800 x 800 x 95	YES	52E8	2SJ00808060E
KPZ 2J	300/600 kg	100/200 g	800 x 800 x 95	No	5218	2SJM08080600
KPZ 2JME	600/1200 kg	200/500 g	800 x 800 x 95	YES	52E8	2SJM0808120E
KPZ 2JM	600/1200 kg	200/500 g	800 x 800 x 95	No	5218	2SJM08081200
KPZ 2JE	1500 kg	500 g	800 x 800 x 95	YES	52E8	2SJ00808150E
KPZ 2J	1500 kg	500 g	800 x 800 x 95	No	5218	2SJ008081500
KPZ 2JE	2000 kg	1000 g	800 x 800 x 95	YES	52E8	2SJ00808200E
KPZ 2J	2000 kg	1000 g	800 x 800 x 95	No	5218	2SJ008082000
KPZ 2JM	1000/2000 kg	200/500 g	800 x 800 x 95	No	5218	2SJM08082000
KPZ 2JME	1500/3000 kg	500/1000 g	800 x 800 x 95	YES	52E8	2SJM0808300E
KPZ 2JM	1500/3000 kg	500/1000 g	800 x 800 x 95	No	5218	2SJM08083000
KPZ 2JE	300 kg	100 g	1000 x 1000 x 95	YES	52E8	2SJ01010030E
KPZ 2JM	150/300 kg	50/100 g	1000 x 1000 x 95	No	5218	2SJM10100300
KPZ 2JE	600 kg	200 g	1000 x 1000 x 95	YES	52E8	2SJ01010060E
KPZ 2J	300/600 kg	100/200 g	1000 x 1000 x 95	No	5218	2SJ010100600
KPZ 2JME	600/1200kg	200/500 g	1000 x 1000 x 95	YES	52E8	2SJM1010120E
KPZ 2JM	600/1200kg	200/500 g	1000 x 1000 x 95	No	5218	2SJM10101200
KPZ 2JE	1500 kg	500 g	1000 x 1000 x 95	YES	52E8	2SJ01010150E
KPZ 2J	1500 kg	500 g	1000 x 1000 x 95	No	5218	2SJ010101500
KPZ 2JE	2000 kg	1000 g	1000 x 1000 x 95	YES	52E8	2SJ01010200E
KPZ 2J	2000 kg	1000 g	1000 x 1000 x 95	No	5218	2SJ010102000
KPZ 2JM	1000/2000 kg	200/500 g	1000 x 1000 x 95	No	5218	2SJM10102000
KPZ 2JME	1500/3000 kg	500/1000 g	1000 x 1000 x 95	YES	52E8	2SJM1010300E
KPZ 2JM	1500/3000 kg	500/1000 g	1000 x 1000 x 95	No	5218	2SJM10103000
KPZ 2JE	600kg	200 g	1250 x 830 x 95	YES	52E8	2SJ01208060E
KPZ 2J	600kg	200 g	1250 x 830 x 95	No	5218	2SJ012080600
KPZ 2JME	600/1200kg	200/500 g	1250 x 830 x 95	YES	52E8	2SJM1208120E
KPZ 2JM	600/1200kg	200/500 g	1250 x 830 x 95	No	5218	2SJM12081200
KPZ 2JE	1500 kg	500 g	1250 x 830 x 95	YES	52E8	2SJ01208150E
KPZ 2J	1500 kg	500 g	1250 x 830 x 95	No	5218	2SJ012081500
KPZ 2JE	2000 kg	1000 g	1250 x 830 x 95	YES	52E8	2SJ01208200E
KPZ 2J	2000 kg	1000 g	1250 x 830 x 95	No	5218	2SJ012082000
KPZ 2JM	1000/2000 kg	200/500 g	1250 x 830 x 95	No	5218	2SJM12082000
KPZ 2JME	1500/3000kg	500/1000 g	1250 x 830 x 95	YES	52E8	2SJM1208300E
KPZ 2JM	1500/3000kg	500/1000 g	1250 x 830 x 95	No	5218	2SJM12083000
KPZ 2JE	600kg	200 g	1250 x 1000 x 95	YES	52E8	2SJ01210060E
KPZ 2J	600kg	200 g	1250 x 1000 x 95	No	5218	2SJ012100600
KPZ 2JME	600/1200kg	200/500g	1250 x 1000 x 95	YES	52E8	2SJM1210120E
KPZ 2JM	600/1200kg	200/500g	1250 x 1000 x 95	No	5218	2SJM12101200
KPZ 2JE	1500 kg	500 g	1250 x 1000 x 95	YES	52E8	2SJ01210150E
KPZ 2J	1500 kg	500 g	1250 x 1000 x 95	No	5218	2SJ012101500
KPZ 2JE	2000 kg	1000 g	1250 x 1000 x 95	YES	52E8	2SJ01210200E
KPZ 2J	2000 kg	1000 g	1250 x 1000 x 95	No	5218	2SJ012102000
KPZ 2JM	1000/2000 kg	200/500 g	1250 x 1000 x 95	No	5218	2SJM12102000
KPZ 2JME	1500/3000 kg	500/1000 g	1250 x 1000 x 95	YES	52E8	2SJM1210300E
KPZ 2JME	1500/3000 kg	500/1000 g	1250 x 1000 x 95	No	5218	2SJM12103000
KPZ 2JE	600 kg	200 g	1250 x 1250 x 95	YES	52E8	2SJ01212060E
KPZ 2J	600 kg	200 g	1250 x 1250 x 95	No	5218	2SJ012120600
KPZ 2JME	600/1200 kg	200/500 g	1250 x 1250 x 95	YES	52E8	2SJM1212120E
KPZ 2JM	600/1200 kg	200/500 g	1250 x 1250 x 95	No	5218	2SJM12121200
KPZ 2JE	1500 kg	500 g	1250 x 1250 x 95	YES	52E8	2SJ01212150E
KPZ 2J	1500 kg	500 g	1250 x 1250 x 95	No	5218	2SJ012121500
KPZ 2JE	2000 kg	1000 g	1250 x 1250 x 95	YES	52E8	2S001212200E
KPZ 2JE	2000 kg	1000 g	1250 x 1250 x 95	No	5218	2SJ012122000
KPZ 2JM	1000/2000 kg	200/500 g	1250 x 1250 x 95	No	5218	2SJM12122000
KPZ 2JME	1500/3000 kg	500/1000 g	1250 x 1250 x 95	YES	52E8	2SJM1212300E
KPZ 2JME	1500/3000 kg	500/1000 g	1250 x 1250 x 95	No	5218	2SJM12123000

... please contact us for special requests!

Ausführung	Kapazität	Teilung	Abm. /mm	Eichf.	Anzeige	Artikel-Nr
KPZ 2JE	600 kg	200 g	1250 x 1500 x 95	YES	52E8	2SJ01215060E
KPZ 2J	600 kg	200 g	1250 x 1500 x 95	No	5218	2SJ012150600
KPZ 2JME	600/1200kg	200/500g	1250 x 1500 x 95	YES	52E8	2SJM1215120E
KPZ 2JM	600/1200kg	200/500g	1250 x 1500 x 95	No	5218	2SJM12151200
KPZ 2JE	1500 kg	500 g	1250 x 1500 x 95	YES	52E8	2SJ01215150E
KPZ 2J	1500 kg	500 g	1250 x 1500 x 95	No	5218	2SJ012151500
KPZ 2JE	2000 kg	1000 g	1250 x 1500 x 95	YES	52E8	2SJ01215200E
KPZ 2J	2000 kg	1000 g	1250 x 1500 x 95	No	5218	2SJ012152000
KPZ 2JM	1000/2000 kg	200/500 g	1250 x 1500 x 95	No	5218	2SJM12152000
KPZ 2JME	1500/3000 kg	500/1000 g	1250 x 1500 x 95	YES	52E8	2SJM1215300E
KPZ 2JM	1500/3000 kg	500/1000 g	1250 x 1500 x 95	No	5218	2SJM12153000
KPZ 2JE	1500 kg	500 g	1500 x 1500 x 95	YES	52E8	2SJ01515150E
KPZ 2J	1500 kg	500 g	1500 x 1500 x 95	No	5218	2SJ015151500
KPZ 2JE	2000 kg	1000 g	1500 x 1500 x 95	YES	52E8	2SJ01515200E
KPZ 2J	2000 kg	1000 g	1500 x 1500 x 95	No	5218	2SJ015152000
KPZ 2JM	1000/2000 kg	200/500 g	1500 x 1500 x 95	No	5218	2SJM15152000
KPZ 2JME	1500/3000 kg	500/1000 g	1500 x 1500 x 95	YES	52E8	2SJM1515300E
KPZ 2JM	1500/3000 kg	500/1000 g	1500 x 1500 x 95	No	5218	2SJM15153000
KPZ 2E	6000 kg	2000 g	1500 x 1500 x 165	NO	5218	2S0015156000
KPZ 2E	6000 kg	2000 g	1500 x 1500 x 165	YES	52E8	2S001515600E
KPZ 2JE	1500 kg	500 g	1500 x 2000 x 130	YES	52E8	2SJ01520150E
KPZ 2J	1500 kg	500 g	1500 x 2000 x 130	No	5218	2SJ015201500
KPZ 2JE	2000 kg	1000 g	1500 x 2000 x 130	YES	52E8	2SJ01520200E
KPZ 2J	2000 kg	1000 g	1500 x 2000 x 130	No	5218	2SJ015202000
KPZ 2JME	1500/3000 kg	500/1000 g	1500 x 2000 x 130	YES	52E8	2SJM1520300E
KPZ 2JM	1500/3000 kg	500/1000 g	1500 x 2000 x 130	No	5218	2SJM15203000
KPZ 2E	6000 kg	2000 g	1500 x 2000 x 165	No	5218	2S0015206000
KPZ 2E	6000 kg	2000 g	1500 x 2000 x 165	YES	52E8	2S001520600E
KPZ 2JE	1500 kg	500 g	2000 x 2000 x 130	YES	52E8	2SJ02020150E
KPZ 2J	1500 kg	500 g	2000 x 2000 x 130	No	5218	2SJ020201500
KPZ 2JE	2000 kg	1000 g	2000 x 2000 x 130	YES	52E8	2SJ02020200E
KPZ 2J	2000 kg	1000 g	2000 x 2000 x 130	No	5218	2SJ020202000
KPZ 2JME	1500/3000 kg	500/1000 g	2000 x 2000 x 130	YES	52E8	2SJM2020300E
KPZ 2JM	1500/3000 kg	500/1000 g	2000 x 2000 x 130	No	5218	2SJM20203000
KPZ 2E	6000 kg	2000 g	2000 x 2000 x 165	No	5218	2S0020206000
KPZ 2E	6000 kg	2000 g	2000 x 2000 x 165	YES	52E8	2S002020600E

KPZ price includes complete scale with indicator.

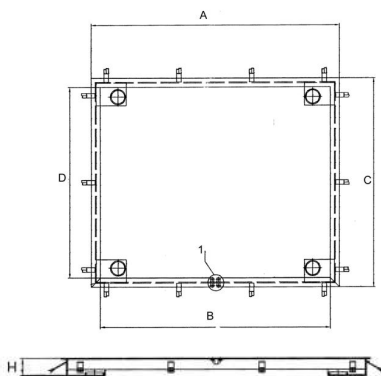

Pit frame for KPZ 2	A	B	C	D	H	Article No.
800 x 800 do 3000kg	920	820	920	820	120	25S008083000
830 x 1250 do 3000kg	1370	1270	950	850	120	25S008123000
1000 x 1000 do 3000kg	1120	1020	1120	1020	120	25S010103000
1000 x 1250 do 3000kg	1370	1270	1120	1020	120	25S010123000
1250 x 1250 do 3000kg	1370	1270	1370	1270	120	25S012123000
1250 x 1500 do 3000kg	1620	1520	1370	1270	120	25S012153000
1500 x 1500 do 3000kg	1620	1520	1620	1520	120	25S015153000
1500 x 1500, 6000kg	1620	1520	1620	1520	175	25S015156000
1500 x 2000 do 3000kg	2120	2020	1620	1520	150	25S015203000
1500 x 2000, 6000kg	2120	2020	1620	1520	175	25S015206000
2000 x 2000 do 3000kg	2120	2020	2120	2020	150	25S020203000
2000 x 2000 6000kg	2120	2020	2120	2020	175	25S020206000

Výřez 1 na náčresu = Odnímatelný kryt otvoru pro průchod kabelu. Minimální velikost prostoru pro zapuštění = A+160mm x C+160mm

... please contact us for special requests!

German design and own EU production guarantees high quality.

Special models are our speciality!

Weights & measures | powder coating | good value for money | solid

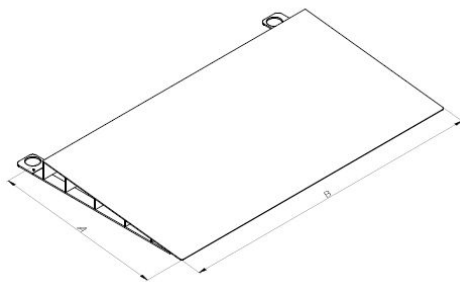

Ramp for KPZ 2

Model	scale capacity	packing dimension
KPZ 2 800 x 800	Up to 3000kg	80 x 120 x 50 cm , 80 kg
KPZ 2 1000 x 1000	Up to 3000kg	130 x 100 x 50 cm, 100 kg
KPZ 2 1250 x 1250	Up to 3000kg	130 x 135 x 50 cm 135 kg
KPZ 2 1250 x 1500	Up to 3000kg	130 x 160 x 50 cm. 160 kg
KPZ 2 1500 x 1500	Up to 3000kg	160 x 160 x 50 cm 190 kg
KPZ 2 1500 x 2000	Up to 3000kg	160 x 200 x 50 cm 330 kg
KPZ 2 1500 x 2000	Up to 6000kg	160 x 200 x 50 cm 385 kg
KPZ 2 2000 x 2000	Up to 6000kg	200 x 200 x 50 cm 490 kg

Einbauinformation / installation information / informace o instalaci**Pit fram KPZ 2 / Fundamentrahmen KPZ 2 / Základový rám KPZ 2**

Abmessungen ca. in mm: Dimension in mm : Rozměry v mm : Zeichnungsausschnitt / Drawing No : 1 =

Kabeldurchführungsöffnung/feed-through hole | Výřez výkresu = otvor k provedení kabelu. | Minimale Einbau-

Grubengröße = A+160mm x C+160mm | Miniale build in hule size = A + 160 mm x C + 160 mm | Minimální velikost

jámy k zabudování = A+160mm x C+160mm

Pit fram KPZ 2 / Fundamentrahmen KPZ 2 / Základový rám KPZ 2

Fundamentrahmen Einbau KPZ 2 / Základový rám montáž KPZ 2. Bitte beachten Sie beim Einbau des Fundamentrahmen folgendes : Pls. Take care by build in the pit frame for following | Vezměte prosím na vědomí, při instalaci základního rámu toto : **Achtung! Eichfähige Ausführung | Caution certified Version | Pozor cejchuschopné provedení:** Bei der KPZ 2E ist das Kabel zwischen Anzeigeelektronik und der Plattform fest angeschlossen. Ein durchführen durch ein Fundamentrohr ist nicht möglich. Es muß ein von oben zu öffnender Kabelkanal verwendet werden! | For the KPZ 2E the cable is fixed between the platform and the Indicator, therefore it is no possibility feedthrough the cable by a pipe. The cable channel must have a possibility to open in top. | U KPZ 2 E je kabel mezi zobrazovací jednotkou a plošinou pevně připojen. Průvod přes základovou trubku není možný. Zhora musí být použit otevírací kabelový kanál. |

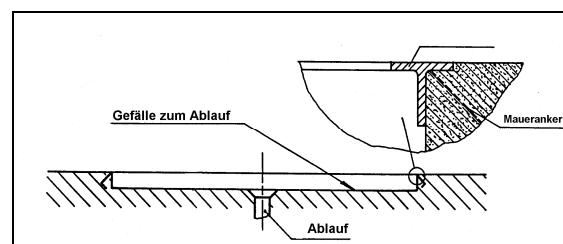
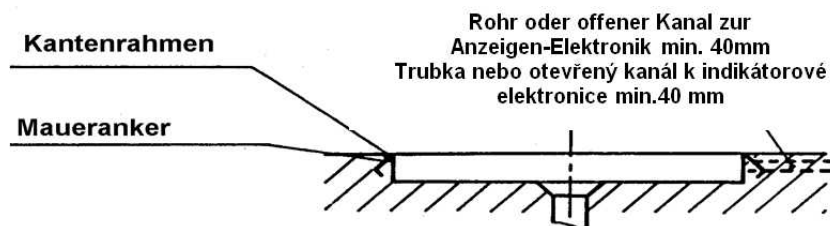

Special requirements for unique loading - please contact us for more information!

German design and own EU production guarantees high quality.

Special models are our speciality!

Weights & measures | powder coating | good value for money| solid



KPZ 2S ECO / Platform scale  / Solid floor scales up to 800 kg
Weights & measures | galvanic Frame | Alumin Top plate | solid
Option : Stainless Top plate possible

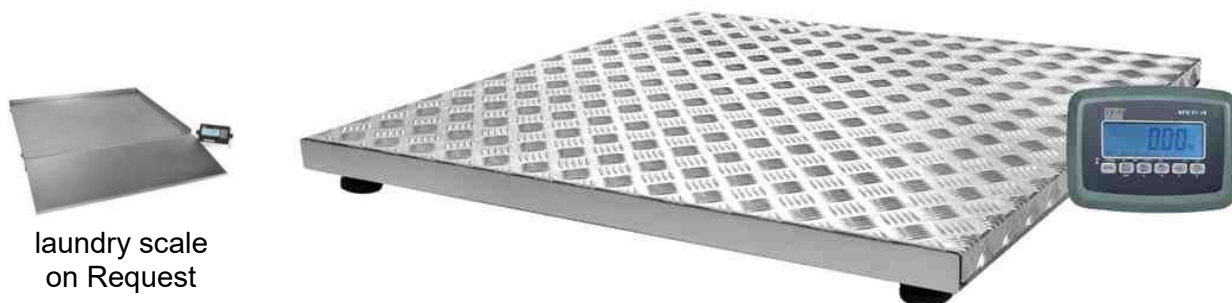









laundry scale
on Request

Solid and stable platform scales series KPZ 2ECO. **German design and own EU production guarantees high quality.** Designed as floor scales, industrial weighing. High accuracy. Maintenance-free durable steel construction. Powder paint coated.

Construction: Robust, maintenance-free, welded steel construction, heavy duty design for industrial use, non-slip finish Aluminw weighing platform, durable black powder coat. **Load cells:** Robust, nickel-plated load cell, IP68, OIML, with a high overload capacity. **Levelling feet.** **Installation:** Adjustable leveling feet, designed for permanent or portable installations, 5m cable to connect digital indicator. **Options:** Extra ramps, Base anchors, Wall mounting for indicator, Indicator stand, Custom sizes and capacities

Standard indicator: KPZ 52-18, **For approved applications:** KPZ 52E-8, **Options for indicators:** Multi range, RS 232 serial interface, Various printers connection, Radio data transfer, WLAN, etc.. Internal battery.

Power Supply : 230 V mains, Power cord. **Approvals:** OIML class III , CE conform.

Type	Kapazität	Teilung	Anzeige	Eichf.	Abm. /mm	Article-No.
KPZ 2 EKO	150/300 kg	50/100 g	KPZ 52-18	Nein	580 x 1010 x 85	2VA006100300
KPZ 2 EKO	300 kg	100 g	KPZ 52E-8	Ja 	580 x 1010 x 85	2VA00610030E
KPZ 2 EKO	150/300 kg	50/100 g	KPZ 52-18	Nein	910 x 1010 x 85	2VA009100300
KPZ 2 EKO	300 kg	100 g	KPZ 52E-8	Ja 	910 x 1010 x 85	2VA00910030E
KPZ 2 EKO	150/300 kg	50/100 g	KPZ 52-18	Nein	740 x 1260 x 85	2VA007120300
KPZ 2 EKO	300 kg	100 g	KPZ 52E-8	Ja 	740 x 1260 x 85	2VA00712030E
KPZ 2 EKO	150/300 kg	50/100 g	KPZ 52-18	Nein	1160 x 1260 x 85	2VA010120300
KPZ 2 EKO	300 kg	100 g	KPZ 52E-8	Ja 	1160 x 1260 x 85	2VA01012030E
KPZ 2 EKO	150/300 kg	50/100 g	KPZ 52-18	Nein	510 x 1510 x 85	2VA005150300
KPZ 2 EKO	300 kg	100 g	KPZ 52E-8	Ja 	510 x 1510 x 85	2VA00515030E
KPZ 2 EKO	150/300 kg	50/100 g	KPZ 52-18	Nein	670x1510x85	2VA006150300
KPZ 2 EKO	300 kg	100 g	KPZ 52E-8	Ja 	670x1510x85	2VA00615030E
KPZ 2 EKO	150/300 kg	50/100 g	KPZ 52-18	Nein	660 x 1810 x 85	2VA007180300
KPZ 2 EKO	300 kg	100 g	KPZ 52E-8	Ja 	660 x 1810 x 85	2VA00718030E
KPZ 2A	1500 kg	500 g	KPZ 52-18	Nein	2200x920mm	2AOH09221500
KPZ 2AE	1500 kg	500 g	KPZ 52E-8	Ja 	2200x920mm	2AOH0922150E

KPZ price includes complete scale with indicator.

Packing Dim. KPZ 2 EKO	scale capacity	packing dimension
KPZ 2EKO 580 x 1010 x 85	Up to 300kg	80 x 120 x 50 cm, 40 kg
KPZ 2EKO 910 x 1010 x 85	Up to 300kg	100 x 120 x 50 cm, 50 kg
KPZ 2EKO 740 x 1260 x 85	Up to 300kg	80 x 120 x 50 cm, 50 kg
KPZ 2EKO 1160 x 1260 x 85	Up to 300kg	125 x 125 x 50 cm, 65 kg
KPZ 2EKO 510 x 1510 x 85	Up to 300kg	80 x 160 x 50 cm, 50 kg
KPZ 2EKO 670x1510x 85	Up to 300kg	80 x 160 x 50 cm, 55 kg
KPZ 2EKO 660 x 1810 x 85	Up to 300kg	80 x 185 x 50 cm, 60 kg

... please contact us for special requests!

German design and own EU production guarantees high quality.



KPZ 2B / Barrel Frame scale

Solid floor scales up to 1.000 kg for industrial use

Weights & measures | powder coating | good value for money | solid



Typ	Capacity	Division	Indicator	Approval possible	Dim. mm	Article-No	
KPZ 2B	400 kg	100 g	KPZ 52-18	No	600 x 600 x 95	2BS006060400	
KPZ 2BM	300/600kg	100/200g	KPZ 52-18	No		2BSM060606000	
KPZ 2B	600 kg	200 g	KPZ 52-18	No		2BS006060600	
KPZ 2B	600 kg	200 g	KPZ 52E-8	Yes 		2BS00606060E	
Option		indicator stand					

KPZ price includes complete scale with indicator.

Option : Pitframe and Ramp	Article-Nr
Pitframe KPZ 2, Steel, 600 x 600 mm	125006060300
Ramp for KPZ 2, steel, 600 mm up to 3t, long 800 mm	121006060300

Packing dimension	
Type	Dimension
KPZ 2B	130 x 84 x 50 cm, ca 80 kg

Solid and stable platform scales series KPZ 2B. **German design and own EU production guarantees high quality.** Designed as floor scales, industrial weighing. High accuracy. Maintenance-free durable steel construction. Powder paint coated.

Construction: Robust, maintenance-free, welded steel construction, heavy duty design for industrial use, non-slip finish weighing platform, durable black powder coat. **Load cells:** Robust, nickel-plated load cell, IP68, OIML, with a high overload capacity. **Levelling feet.** **Installation:** Adjustable leveling feet, designed for permanent or portable installations, 5m cable to connect digital indicator. **Options:** Extra ramps, Base anchors, Wall mounting for indicator, Indicator stand, Custom sizes and capacities

Standard indicator: KPZ 52-18, **For approved applications:** KPZ 52E-8, **Options for indicators:** Multi range, RS 232 serial interface, Various printers connection, Radio data transfer, WLAN, etc.. Internal battery. **Approvals:** OIML class III , CE conform. **Power Supply** : 230 V mains, Power cord

... please contact us for special requests!

Weights & measures | powder coating | good value for money | solid

German design and own EU production guarantees high quality.

Special models are our speciality!



KPZ 2D / Low construction platform scale

Robust platform scale with very flat drive-on! Including 1 x ramp

Weights & measures | powder coating | Eclectic | durable

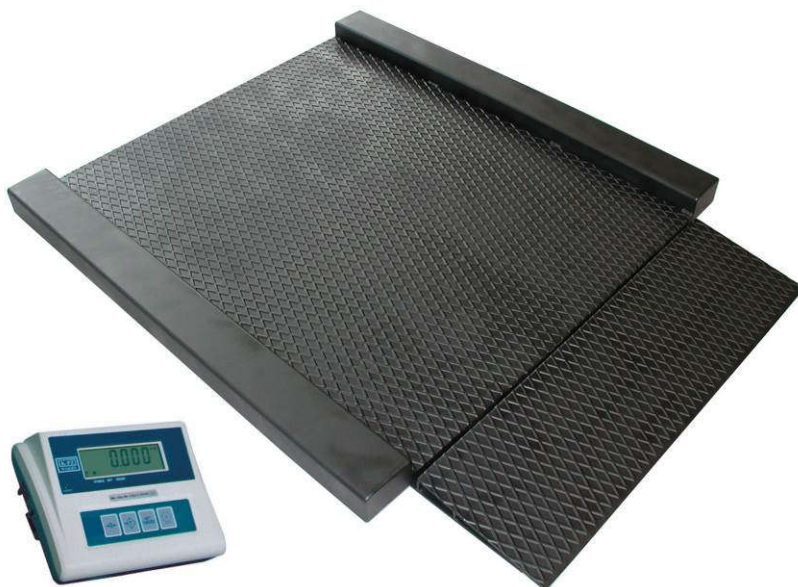

Low construction scale, type: KPZ 2D, for use with or without EU approval.

Low construction scale with drive in option and passing drive option, in special construction with lowered weighing platform. Possibility to easy drive on with heavy load through 1 ramp (standard) or two ramps (option).

Low construction scale KPZ 2 D, high quality industrial platform, long service life, solid and stable steel construction black powder painted, structured plate, with 1 x ramp. **Load cells:** High quality load cells DMS type KPZ 502E-3, IP 67, OIML C3. **Indicator:** KPZ 52E-8 (possibility to deliver without indicator), 16ft cable, sheltered at way out of scale in case of mechanical damage. **Certification:** EC approval possibility class III, Declaration of Conformity.

Solid and stable platform scales series KPZ 2B. **German design and own EU production guarantees high quality.** Designed as floor scales, industrial weighing. High accuracy. Maintenance-free durable steel construction. Powder paint coated.

Construction: Robust, maintenance-free, welded steel construction, heavy duty design for industrial use, non-slip finish weighing platform, durable black powder coat. **Load cells:** Robust, nickel-plated load cell, IP68, OIML, with a high overload capacity. **Levelling feet.** **Installation:** Adjustable leveling feet, designed for permanent or portable installations, 5m cable to connect digital indicator. **Options:** Extra ramps, Base anchors, Wall mounting for indicator, Indicator stand, Custom sizes and capacities

Standard indicator: KPZ 52-18, **For approved applications:** KPZ 52E-8, **Options for indicators:** Multi range, RS 232 serial interface, Various printers connection, Radio data transfer, WLAN, etc.. Internal battery. **Approvals:** OIML class III , CE conform. **Power Supply** : 230 V mains, Power cord

... please contact us for special requests!

German design and own EU production guarantees high quality.

Special models are our speciality!

Weights & measures | powder coating | good value for money | solid



OPTION



ATEX konform

Type	Kapazität	Teilung	Anzeige	Eichf.	Abm. /mm	Article-No.
KPZ 2DE	300 kg	100 g	KPZ 52E-8	Ja (III) M	500 x 600	2D000506030E
KPZ 2D	300 kg	100 g	KPZ 52-18	Nein	500 x 600	2D0005060300
KPZ 2DM	300/600 kg	100/200 g	KPZ 52-18	Nein	500 x 600	2DM005060600
KPZ 2DE	600 kg	200 g	KPZ 52E-8	Yes (III) M	500 x 600	2D000506060E
KPZ 2D	600 kg	200 g	KPZ 52-18	Nein	500 x 600	2D0005060600
KPZ 2DE	300 kg	100 g	KPZ 52E-8	Ja (III) M	800 x 800	2D000808030E
KPZ 2D	300 kg	100 g	KPZ 52-18	Nein	800 x 800	2D0008080300
KPZ 2DM	300/600 kg	100/200 g	KPZ 52-18	Nein	800 x 800	2DM008080600
KPZ 2DE	600 kg	200 g	KPZ 52E-8	Ja (III) M	800 x 800	2D000808060E
KPZ 2D	600 kg	200 g	KPZ 52-18	Nein	800 x 800	2D0008080600
KPZ 2DM	300/600 kg	100/200 g	KPZ 52-18	Nein	700 x 1000	2DM007100600
KPZ 2DE	600 kg	200 g	KPZ 52E-8	Ja (III) M	700 x 1000	2D000710060E
KPZ 2D	600 kg	200 g	KPZ 52-18	Nein	700 x 1000	2D0007100600
KPZ 2DE	600 kg	200 g	KPZ 52E-8	Ja (III) M	1060 X 1250	2D001112060E
KPZ 2D	600 kg	200 g	KPZ 52-18	Nein	1060 X 1250	2D0011120600
KPZ 2DM	750/1500 kg	200/500 g	KPZ 52-18	Nein	1060 X 1250	2DM011121500
KPZ 2DE	1500 kg	500 g	KPZ 52E-8	Ja (III) M	1060 X 1250	2D001112150E
KPZ 2D	1500 kg	500 g	KPZ 52-18	Nein	1060 X 1250	2D0011121500
KPZ 2DM	1500/3000 kg	500/1000 g	KPZ 52-18	Nein	1060 X 1250	2DM011123000
KPZ 2DE	600 kg	200 g	Ja (III) M	Ja (III) M	1250 x 1500	2D001215060E
KPZ 2D	600 kg	200 g	KPZ 52-18	Nein	1250 x 1500	2D0012150600
KPZ 2DM	750/1500 kg	200/500 g	KPZ 52-18	Nein	1250 x 1500	2DM012151500
KPZ 2DE	1500 kg	500 g	KPZ 52E-8	Ja (III) M	1250 x 1500	2D001215150E
KPZ 2D	1500 kg	500 g	KPZ 52-18	No	1250 x 1500	2D0012151500
KPZ 2DE	600 kg	200 g	KPZ 52E-8	Ja (III) M	1500 x 1500	2D001515060E
KPZ 2D	600 kg	200 g	KPZ 52-18	Nein	1500 x 1500	2D0015150600
KPZ 2DM	750/1500 kg	200/500 g	KPZ 52-18	Nein	1500 x 1500	2DM015151500
KPZ 2DE	1500 kg	500 g	KPZ 52E-8	Ja (III) M	1500 x 1500	2D001515150E
KPZ 2D	1500 kg	500 g	KPZ 52-18	Nein	1500 x 1500	2D0015151500

KPZ price includes complete scale with indicator and 1 Ramp.

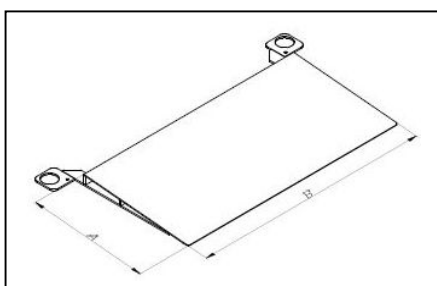

Extra ramp for KPZ 2D	A /B mm	Art. Nr.
Extra ramp for KPZ 2D, 500 mm	500/500	21DS05050600
Extra ramp for KPZ 2D, 800 mm	500/800	21DS05080600
Extra ramp for KPZ 2D, 700 mm	500/700	21DS05070600
Extra ramp for KPZ 2D, 1060 mm	500/1060	21DS05113000
Extra ramp for KPZ 2D, 1250 mm	500/1250	21DS05121500
Extra ramp for KPZ 2D, 1500 mm	500/1500	21DS05151500

Options / accessories / extra charge	Article-Nr.
Go through stop for KPZ 2 D, 500 x 600 mm	2DS001070600
Go through stop for KPZ 2 D, 800 x 800 mm	2DS001100600
Go through stop for KPZ 2 D, 700 x 1000 mm	2DS001090600
Go through stop for KPZ 2 D, 1250 x 1060 mm	2DS001133000
Go through stop for KPZ 2 D, 1250 x 1500 mm	2DS001151500
Go through stop for KPZ 2 D, 1500 x 1500 mm	2DS001171500

German design and own EU production guarantees high quality.

Other capacity, division, option and dimension on request.



Dimension of KPZ 2D

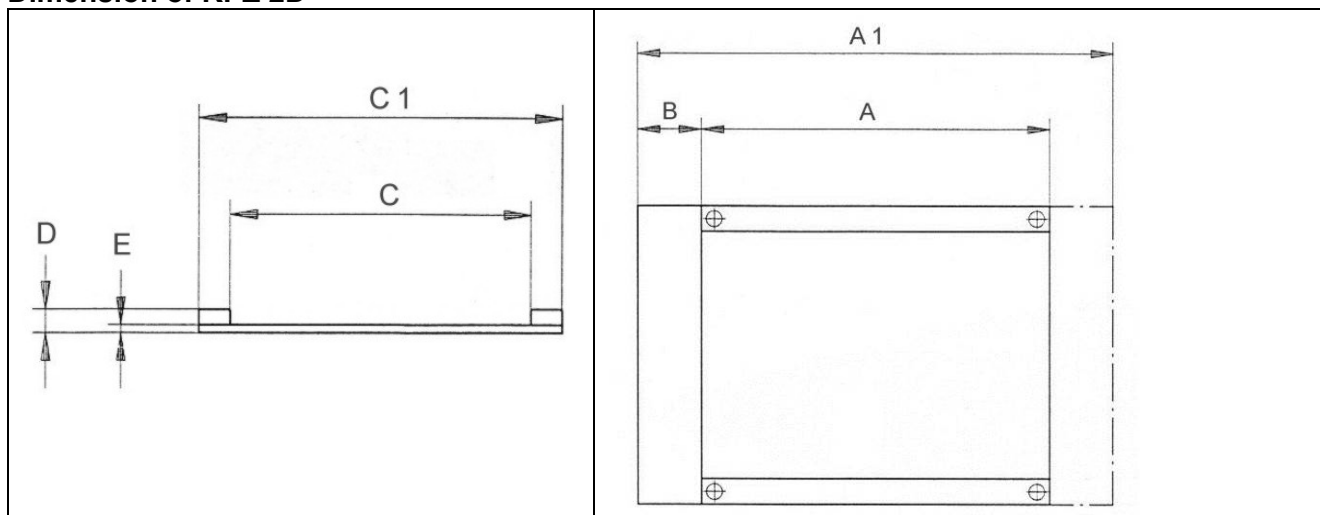

Capacity	Size	A	A1	B	C	C1	D	E
600kg	600 x 500	600	1600	500	500	740	80	45
600kg	800 x 800	800	1800	500	800	1040	80	45
600kg	1000 x 700	1000	2000	500	700	940	80	45
1500kg	1250 x 1060	1250	2250	500	1060	1300	80	45
3000kg	1250 x 1060	1250	2250	500	1060	1300	80	45
1500kg	1250 x 1500	1250	2250	500	1500	1740	80	45
1500kg	1500 x 1500	1500	2500	500	1500	1740	80	45

Dimension in mm

Packing dimension		
Type	scale capacity	packing dimension
KPZ 2D 500x600	Up to 600kg	80 x 120 x 50 cm , 80 kg
KPZ 2D 800x800	Up to 600kg	80 x 120 x 50 cm , 105 kg
KPZ 2D 700x1000	Up to 600kg	130x 130 x 50 cm , 115 kg
KPZ 2D 1250x1060	Up to 3000kg	130x 130 x 50 cm , 180 kg
KPZ 2D 1250x1500	Up to 1500kg	160x 160 x 50 cm , 255 kg
KPZ 2D 1500x1500	Up to 1500kg	160x 200 x 50 cm , 315 kg

... please contact us for special requests!

KPZ price includes complete scale with indicator.

Special requirements for unique loading - please contact us for more information!

German design and own EU production guarantees high quality.

Special models are our speciality!

Weights & measures | powder coating | good value for money | solid



KPZ 2DX (E) / drive-through scale

Space-saving drive-through scale with integrated ramps. For trolleys

Approval | powder coated | durable

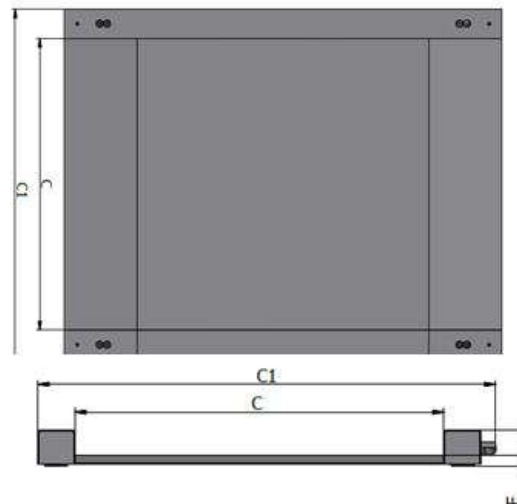

Robust drive-through scale of the KPZ 2DX series is suitable for : laundry trolleys, lattice trolleys, wire box trolleys, transport carts, container trolleys, garbage cans. Floor scale for driving through with 2 integrated ramps. For use that is subject to verification or non-verification.

German design and own EU production guarantees high quality.

Construction: KPZ 2DX drive-through scale. Robust, maintenance-free, welded steel construction incl. 2 integrated ramps, smooth weighing platform, height 29mm, resistant black powder coating. Multi-range division (possible), capacity 300 / 600kg 100 / 200g (other capacities possible), weighing surface (WxL) 1000 x 1000 mm (other dimensions possible),. **Load cell:** high-quality, calibratable strain gauge measuring cell, IP 68, OIML C3. Levelling Feet. Display electronics: mentioned below, complete. with charger, with 5m connection cable, on the platform side protected against damage. Approvals: EU type-approval class III, through increased resolution for weighings not subject to verification.

Typ	Cap. kg	Div. g	Dim. mm	Eichfähig	Indicator	Art.-Nr.
KPZ 2 DX	300/600	100/200	1000 x1000		without	2SDX101060OH
KPZ 2 DX	300/600	500/1000	1000 x1000	No	KPZ 52 16-1	2DXM10100600
KPZ 2 DXE	300/600	500/1000	1000 x1000	YES 	KPZ 52E16-1	2DXM1010060E

Capacity	Weighing Surface	A	A1	B	C	C1	D	E
300/600kg	1000 x 1000 mm	1000	1500	250	1000	1242	96	29

.....pls contact us for special request !

German design and own EU production guarantees high quality.

KPZ price includes complete scale with indicator.

Weights & measures | powder coating | good value for money| solid



KPZ 2 DIA Scale for weight for wheelchair users, with 2 integrated ramps

Extremely solid and stable **aluminum** construction with wheels and Handle for easy handling. Complete with battery and charger.

Load cells: 4 high quality, OIML approved C 3, DMS load cell, IP 67/68, type KPZ 502E-3.
Certification: EU type approved version, CE - conform, approved.
Capacity : 0 kg to 300 kg, Div. : 0.1 kg.

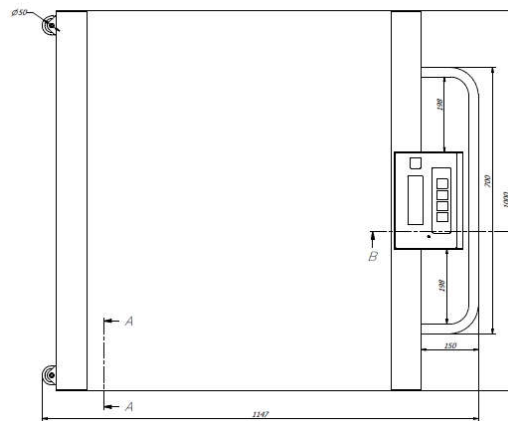
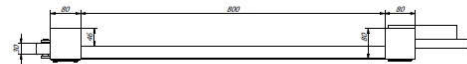

Typ	Capacity	Div.	Dim. mm.	Approval possibility	Indicator	Art.-No
KPZ 2 DIA	300 kg	100 g	0,80 x 0,80/1,00m	No	KPZ 52E91/IP67	2DIA081003000
KPZ 2 DIA	300 kg	100 g	0,80 x 0,80/1,00m	YES	KPZ 52E91/IP67	2DIA08100300E

... please contact us for special requests!

German design and own EU production guarantees high quality.

Special models are our speciality!



KPZ Indicators

 <p>KPZ 52E-7</p> <p>Klasse III M</p>	 <p>KPZ 52E-7/1</p> <p>Klasse III M</p>	 <p>KPZ 56E-4</p> <p>Klasse III M</p>
 <p>KPZ 52E-9-1</p> <p>Klasse III M</p>	 <p>KPZ 51E-9-2</p> <p>Klasse III M</p>	 <p>KPZ 51E11 - 13</p>
 <p>KPZ 58-2</p> <p>Klasse III M</p>	 <p>KPZ 52-19</p>	 <p>Big display/second display</p>
 <p>KPZ 54E-*</p> <p>Klasse III M</p>	 <p>KPZ 54E-*</p> <p>Klasse III M</p>	

KPZ Indikátory

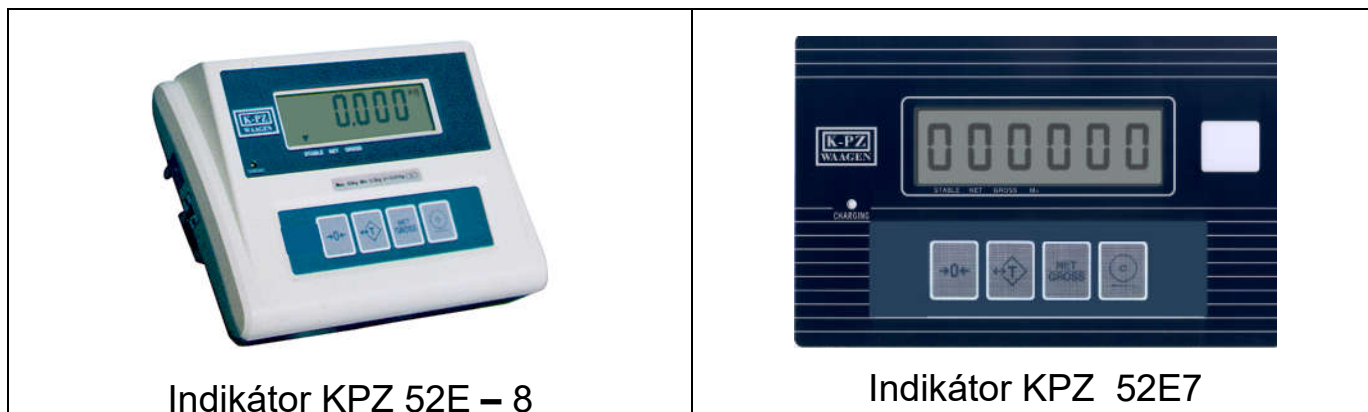

Klasse



Multirange division : See technical data of the scale. OIML Class



Description KPZ 52(E) - 7

Robust external case made from ABS incorporating a water-proof front keypad with large function keys. 6-digit, 26 mm high LCD – Display with back-light function providing a clear and easily readable weight indication. Operating temperature – 10 to + 40 °C. 230 Volt-operation.

Function : automatic and manual Zero setting. Tare setting up to 100 %, switch Net and gross weight repeatedly. Optional RS 232 Data output and addition sum printing, minus indication, LCD back-light (3 settings), audible/visible alarm/check HIGH-OK-LOW (That means two available value of weight), automatic selftest, Error message on display.

LED indication for : Zero, Tare weight, stabile, LOW Bat, power, addition memory.







Options: Configurable RS 232 output, data output (different formats), Roller printer, label printer, set point (High-OK-Low),

Key	Description
ON/OFF	This key is installed on the ABS housing. This key is used to switch the indicator ON or OFF. When activated the display shows the $\rightarrow 0 \leftarrow$ signal is on.
$\rightarrow 0 \leftarrow$	If the LCD Display is not indicating 0.00 , press this key to re-zero the scale. The display indicates that the ZERO signal is now on. The unit can zero $\pm 2\%$ of the max. capacity. Using this switch do not change the range of maximal capacity.
	This key is used to carry out tare and zero settings, when an existing weight is on the scale. If a TARE weight is stored, the Tare Signal will indicate over Net . As soon as you remove the TARE weight re-set to ZERO by the user of the scale, the display shows the weight with a minus symbol in front on the LCD display. The maximum weighing range is reduced for the tare value. Tare capability is 100% of the scale capacity, and can be used repeatedly. Multiple tare is possible. Negative weight values can be moved to 0.00 .
NET GROSS	This key is used to switch between net and gross weight repeatedly. The display indicate Net or τ GROSS. This $\frac{\text{NET}}{\text{GROSS}}$ key can be used only when the scale is in the tare mode. By showing the Gross value (τ GROSS) the other keys are closed.
	If a printer interface is installed, this key will print out (printer version) or transfer the weight data being displayed . The weight value is stored in the data logger. The display indicate τ M+ .To print the grand total of all printed weights the weight must be removed. The display shows $\rightarrow 0 \leftarrow$. Then press the  key twice the total sum of the weighing results will be printed .

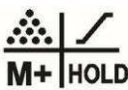
KPZ Indicators



Robust external case including a water-proof front keypad with large function keys. 6- digit, 30 mm high LCD – Display with blue back-light function providing a clear and easily readable weight indication. Operating temperature – 10 to + 40 °C. 230 Volt-operation. Battery operation possible. **Function** : automatic and manual Zero setting. Tare setting up to 100 %, pretare function, switch Net and gross weight repeatedly. Optional RS 232 Data output and addition sum printing, minus indication, HIGH-OK-LOW function, totalizing function, automatic selftest, Error message on display. **LED indication for** : Zero, Tare weight, stable, LOW Bat, HI LOW OK .
Options: RS 232 output, data output, Roller printer,

Key	Function	Hold for 1 sec.
	Printout / data output (Option)	Communication settings
Σ	Totalizing	
	Modus selection / Function	/
	Switching between net and gross weight (net mode)	
UNIT	switching units	/
	Switch between weight / unit weight (piece counting mode)	
	Tare	<ol style="list-style-type: none"> 1. Backlight 2. Switch on zero setting 3. Gravitation value
	Pretare	
	Zero	battery voltage

KPZ Indicators

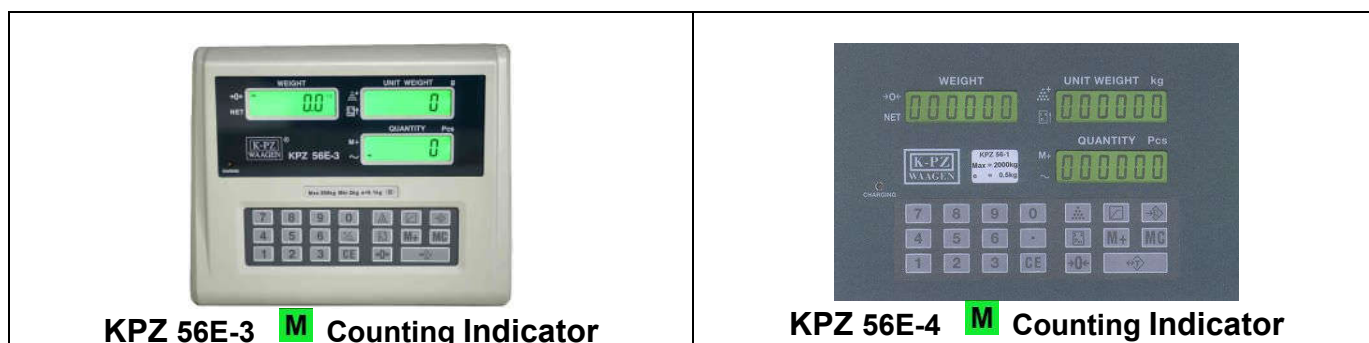

Optimal unit weight for the piece count: 1/5 of the scale division.

This high-quality Parts Counting Indicator can be used in all types of uncertified and for trade weighing applications. Due to the high external resolution and the 20x expanded internal resolution, the unit is ideally suitable for both small and large item component counting. The expanded internal resolution of the indicator provides clear signal stability and repeatability. The 3 window highly visible LCD-Display provides the operator with clear data information. Additionally, with the robust construction of a steel housing, built-in rechargeable battery, and the simple to operate dust and waterproof front keypad, makes this part counting indicator a valuable tool for all industrial weighing & counting applications.

Description of Keypad

0 to 9 and .	Use to enter piece weight, total quantity or Tare value.
CE:	Deletes all value entered via the keypad.
→0←	1) Use this key to Zero the scale 2) Use this key by pressing twice to enter backlight options (see Backlight Function)
→T←	Use this key to Tare the scale
	Use this key to confirm entered quantity.
	Use this key to confirm entered piece weight.
	Use this key to pre-set upper count limit, when the value is achieved an audible signal will be emitted.
→M←	Use this key to save a piece weight in memory.
M+	Count accumulation key.
MC	Deletes all accumulation count in memory.

Standard features :Indicator: Display indication 1/30.000, internal divisions 1/600.000. Built-in calibration routine. Automatic & manual zero setting. 100% Tare. Piece Counting. The tare value and the piece weight can be weighed or entered via the front keyboard. The indicator has a 10 piece weight memory. 3 window LCD display with back-lighting option showing weight, quantity and individual piece weight. Counting accumulation. Audible peak alarm for Multi counting applications. Symbol indication shown at display for : Power re-charging control, LO-BAT. Zero, Tare, Stable, Memory, Piece number, Piece weight.

Options :

Factory configured serial interface (RS 232). With this interface in addition to date, weight & count information, two additional 15 character line entries can be included (for example Item number, operator number etc.) Printing from this interface via a single tally roll printer or label printer which will print all data in a numerical format, or in a range of standard **Barcodes**.

KPZ Indicators

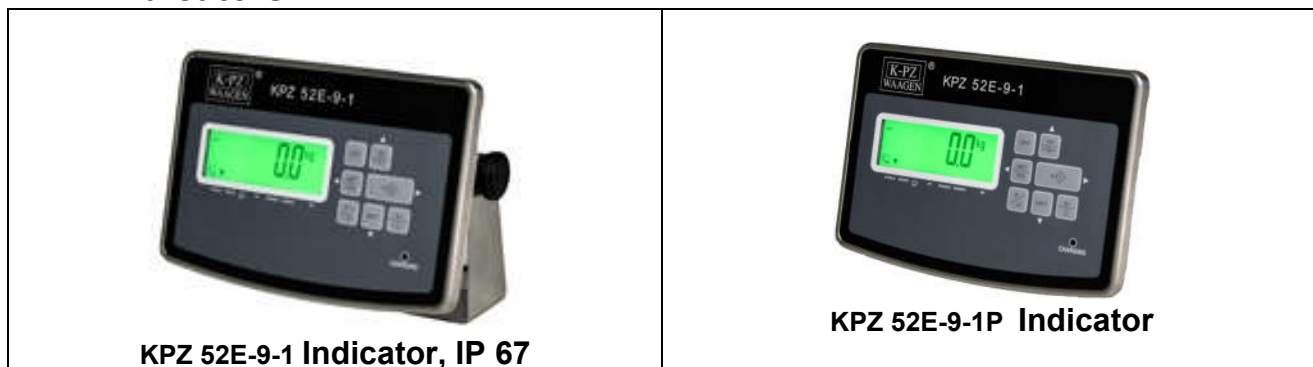

OIML trade approved Class III **M**, 10.000 e

Technical data: Indicator: **KPZ 52E-9-1** robust, stainless steel housing **IP 67**, user-friendly, large function keys. LCD display: 6 digit, various symbols, backlight, high of digits 25 mm. Operating temperature from -10°C up to $+40^{\circ}\text{C}$, operation 230 Volt through external power supply, inbuilt battery (possibility of battery operation).

Functions: automatic and manual zero setting, switch Net/Gross weight, 100% tare, multiple tare, unit switching, simple piece counting by reference no. 10, 20, 50, 100 i 200. Possibility to enter data and bring out data through serial interface (optional): computer functional control, possibility of choosing different exit formats, **printout in simple format**, edition activation: via computer, continuously or after zero come back. Minus indication, LCD backlight, automatic shut off after 0-9 minutes, pre-set value control or limit value control LOW – OK - HIGH (any two weight values to choose, tone or light signal), electronic stabilization filter and signal distortion, automatic self test, error messages.

Indication: zero setting, gross, net, stability, LOW-Bat indication, pre-set/limit value, too small piece quantity or too small weight. **LED:** charging status. **Options:** serial interface RS 232, battery, label printer

Key functions:

Key	Description
ON	<i>switch the indicator ON</i>
→0←	<i>Switch the indicating to 0.00</i>
OFF	<i>switch the indicator OFF</i>
↔T	<i>TARE function</i>
NET GROSS	<i>Switch over Net / Gross Tare, repeatedly</i>
UNITS	<i>Switch over weighing units</i>
F/HR	<i>In approval version: High resolution indication (5 sec)</i>
M+	<i>Totalizing and printout/ data output</i>

Robust external case including a water-proof front keypad with large function keys. 6-digit, 30 mm high LCD – Display with blue back-light function providing a clear and easily readable weight indication. Operating

KPZ 54-* / Touch screen indicator



- Touch Operating System for user friendly and fastest operations.
- Multi-printer selectable
- Custom printout options,
- Multi -language support
- Report management.
- PC keyboard and Mouse can be connected
- Software upgrade option.
- 9999 products possible to store in memory.
- designed for multiple use, such as Weighing, Target, Counting, Check weighing and Recipe operations.
- 2xUSB port, 1xRS232, optional more ports possible
- 7' or 8' display possible
- Robust ABS or stainless steel housing possible
- Dual scale option (extra charge) possibility



KPZ 51E-45K

IP69K

AISI 304 stainless steel weight Indicator (dimensions: 206x286x108 mm) with 6 PG9 cable glands, **IP69K protection rating**, stainless steel adjustable bracket included (overall dimensions with bracket: 206x290x187 mm). Optionals: panel / desk / column mounting. Six-key membrane keyboard with buzzer. Real-time clock with buffer battery.

Weight reading by another instrument via serial port.

Two serial ports (RS232 and RS485) for connection to:

- PC/PLC up to 32 instruments (max 99 with line repeaters) by ASCII protocol or ModBus RTU.
- Remote display.
- Printer.
- Optional integrated output: Profibus DP, DeviceNet, CANopen, Profinet IO, Ethernet/IP, Ethernet TCP/IP, Modbus/TCP.

Main functions:

- 5 setpoints (4 setpoints if Analog Output is present) configurable as normally open or normally closed. The operator can decide the setpoints activation for the net weight value, gross weight value, otherwise for positive weights or for positive and negative weights.
- Counting.
- Totalizing.
- Setting of hysteresis value for each setpoint.
- 12 groups selection by 5 setpoint from selector switch or contacts (EC/E options).
- Peak holder displaying by closing the Peak contact.
- Net/Gross function by keyboard or external contact.
- Manual adjustment of zero value in case of zero-setting not possible.
- Auto zero function.
- Auto zero-tracking function.
- Print of the weight via keyboard or external contact with date and time.

Operation: The inputs can work as: net/gross weight, zero-setting, peak, print or can be remotely read via protocol.

The outputs can work as setpoints or can be remotely switched via protocol.

Weight transmitter approved OIML R61 (Automatic Gravimetric Filling Instruments) according to WELMEC Guide 8.8:2011 (MID).

approvable EN45501-2014/31/UE-OIML R76:2006

- Maximum number of verification scale intervals n=10000
- Minimum input-voltage per VSI 0.2 μ V
- Weighing range single range or multi range (max 3) or multi interval (max 3)
- Calibration via keyboard is protected through seals for the access to a setting jumper or installer password
- Semi-automatic zero and tare, predetermined tare functions.
- Weight subdivisions displaying (1/10 e)
- The following values can be printed from external contact: net/gross weight; tare; predetermined tare; date; time; ID code (if alibi memory is present)



KPZ 51E-41 indicator

Characteristics:

Software: Base

- Zeroing
- Tare
- Hand tare
- Gross / Net switching
- simple piece counting
- Add function
- automatic zeroing function

Function (Optional):

- Print function including date and time, external button
- I / O inputs as net / gross switching, zeroing, peak value, printout
- I / O outputs as set point function
- Communication protocol via serial interface
- 5 set points (4 set points if analogue output is available) Configurable as open or normally closed. The set points can be set as net weight, gross weight, for positive or for positive and negative weights.
- Setting the hysteresis value for each set point.

Option (extra charge):

- Wall mounting
- Stand
- Battery
- Alibi memory
- Analog output
- I/O's, relay output
- Printer
- Serial interface RS232 and RS485
- Remote display
- Profibus, Ethernet TCP/IP, Modbus, CANopen, DeviceNet.

Power supply:

- Mains 110-240VAC, 3m long cable

Technical Data:

- LCD display, backlit (6 digit 20mm high, semi alphanumeric)
- 16 icon displays
- Robust ABS housing IP67
- Temperature range: -10 ° C to 40 ° C
- dim. 122x226x164mm
- EU type approval Class III to 10,000e

Big display (second display), can be combined with all KPZ Indicator

Model : KPZ GD 1-1

150057052000 Large display KPZ GD1-1, 6-digit, 127 mm LED dot matrix, with 5m connection cable and interface for connection to the display KPZ 52 (E) - *

Model : KPZ GD 2

150057062000 Großanzeige KPZ GD2-1 6-stellig, 76 mm LED's dot Matrix, mit 5m Anschlußkabel und Interface zum Anschluß an die Anzeige KPZ 52 (E)-*



PC Software K-PZ Smart Scale

Software K-PZ Smart Scale is a modern software specially designed to manage weighing data. A custom function selection is possible depending on different stages of development. Moreover, it is possible to customize software according to customer requirements.

It provides an extremely user-friendly interface and easy of operation.

Software used to manage weighing data, transmitted via the interface of the scale.

It saves time and transmission errors that may occur by manual data input.

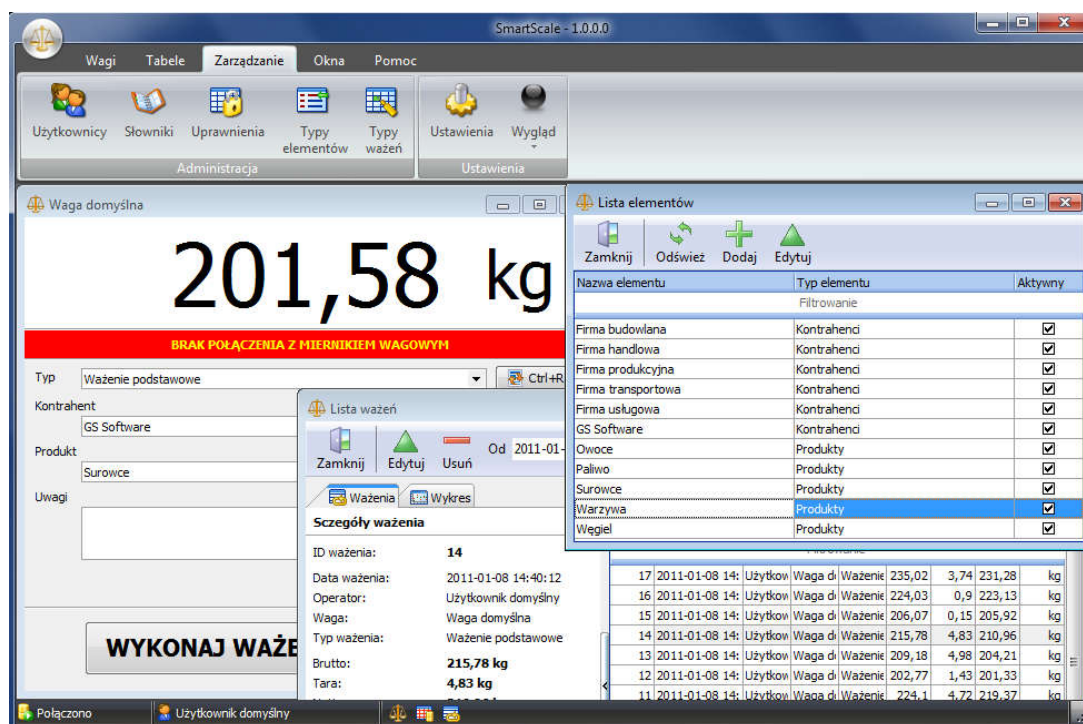

View of the main window

Depending on the configuration following option possible :

- Adjustment of customer-specific data
- Admin data managing
- User managing
- Export to TXT, CSV, RTF, JPG, XLS file
- Print out
- Label printing

Software comes with a USB flash drive activation key.

system Requirements:

Minimum requirements:

- hardware – Processor Intel Pentium 4, 512 MB RAM, 100 MB of the hard drive free;
- software: Windows 2000 (SP4), XP (SP2), Vista, Win7

Depending on version of KPZ Smart Scale , the following functionality is possible:

Function	Programm version		
	Standard	Professional	Premium
Facility to connect only one scale indicator	X		
Facility to connect any number of indicators the same time		X	X
Handling any model of KPZ indicator	X	X	X
Access to weighing list data window	X	X	X
Export weighing list data to the .TXT or .CSV file	X	X	X
Export weighing list data to the .XLS file(installation of MS Excel not necessary)		X	X
Weighing list data overview on the chart	X	X	X
Save the chart (weighing list data) as a picture	X	X	X
Weighing search	X	X	X
Weighing ticket preview	X	X	X
Save weighing ticket as PDF file	X	X	X
Edit data assigned to the weighing	X	X	X
History of weighing changes preview			X
Access to the Report Generator		X	X
Generating report to any data		X	X
Save the report as .PDF file		X	X
Export report data to .RTF, .CSV, .JPEG, XLS file (installation of MS Excel is necessary)		X	X
Export report data to . XLS file (installation of MS Excel not necessary)			X
Using programm as default user (with out Log in-Panel)	X		
Using programm as defined User or Admin		X	X
User Authorization Management			X
Facility to perform weighing without additional data	X	X	X
Facility to perform weighing with additional data: contractor, product, comments,	X	X	X
Facility to perform weighing with additional data: contractor, product, comments, + 2 additional dictionaries, + 2 additional text fields		X	X
Facility to perform weighting with any data type. Possibility to build any data structure.			X
Access to the window allowing to create dictionaries in a database			X
Network version		X	X
Print out as graphic or text mode	X	X	X
Facility to print out the logo on the ticket weighting (graphic mode)	X	X	X
Facility to create license data (one set only)	X		
Facility to create any number of license data set		X	X
Virtual Scales mechanism (planned)		X	X
Label ticket operation (planned)		X	X
Multi-language	X	X	X

Printers for KPZ scales

More printers and options on request!

Thermal printer Favorit 24	
Dimensions	85 x 85,5 mm (B x H)
Own weight	150 g
Power supply	Scale's battery
Interface	serial RS232
Version	Thermo-Direkt-Drucker, 203 dpi,
Paper	Paper width: 57 mm



Ticket printer DR 2	
Dimensions	93x173x190 mm (B x H x T)
Own weight	1,2 kg
Power supply	230 VAC / 20 V DC 2,5 A
Interface	serial RS232, Parallel
Version	Thermo-Direkt-Drucker, 203 dpi,
Paper	Etiquette width : max 61mm



Ticket printer DR 6	
Dimensions	ca. 109 x 171 x 209 mm (B x H x T)
Own weight	ca. 1,2 kg
Power supply	100-240 VAC / 24 VDC 2,1 A
Interface	seriell RS232, Parallel
Version	Thermo-Direkt-Drucker, 203 dpi,
Paper	Etiquette width: 15-60mm



Thermal printer Favorit	
Dimensions	85 x 85,5 mm (B x H)
Own weight	150 g
Power supply	Scale's battery
Interface	serial RS232
Version	Thermo-Direkt-Drucker, 203 dpi,
Paper	Paper width: 57 mm



Rollerprinter DR 7	NEW
Dimensions	110 x 125 x 70 mm (B x H x T)
Own weight	600 g
Power supply	230 VAC / 9 V DC 3,2 A
Interface	RS232, USB
Version	Thermo-Direkt
Paper	Papierbreite: 58mm, 20m, Ø40mm



Rollerprinter DR 7	
Dimensions	160 x 139 x 248 mm (B x H x T)
Own weight	2,3 kg
Power supply	230 VAC / 20 V DC 2,5 A
Interface	serial RS232, Parallel
Version	9- Needle printer, alphanumerischer Ausdruck
Paper	Paper width: 76 , 69,5 or 57,5 mm max. 40 digits on column



K-PZ Waagen
 Kanalsteck 9
 21129 Hamburg
 Tel. 040 / 742174-0
 Fax 040 / 742174-99
 TICKET NO. 1
 Art.-Nr.: 123456
 PCS 40
 APW 100 g
 G 5.001 kg
 T 1.000 kg
 N 4.001 kg



KPZ 719SJDR
Exemplary formats
Indikátor KPZ 52 19



TICKET NO.0001
GS 124.5 kg
TR 20.0 kg
NT 104.5 kg

TICKET NO.0002
GS 124.0 kg
TR 20.0 kg
NT 104.0 kg

TOTAL NUMBER
OF TICKETS 0002
TOTAL WEIGHT
248.5 kg

Indicator KPZ 5218



23/08/2016, 16:42:45

TICKET NO.0001
G 2.0kg
T 0.0kg
N 2.0kg

23/08/2016, 16:43:01

TICKET NO.0002
G 5.6kg
T 0.0kg
N 5.6kg

23/08/2016, 16:43:13

TOTAL NUMBER
OF TICKETS 0002
TOTAL
NET 7.6kg

KPZ printers

Exemplary formats / Indicator KPZ 52(E) – 7 / Indicator KPZ 52(E) - 8

Examples are standard formats to printers KPZ. Possibility computer formats. Possibility of formats on customer request!

Exemplary print out Simple format 3	
S/N	WT/kg
0001	100,0
0002	200,0
0003	300,0
0003	600,0

Exemplary print out Complete format 4	
TICKET NO.0001	
G	100,0g
T	0,0g
N	100,0g
TICKET NO.0002	
G	200,0g
T	0,0g
N	200,0g
TICKET NO.0003	
G	300,0g
T	0,0g
N	300,0g
TOTAL NUMBER OF TICKETS 0003	
TOTAL	
NET	600,0g

G = Gross
T = Tare
N = Netto

Exemplary print out Stable format 5	
S/N	WT/kg
0001	100,0
0002	200,0
0003	300,0
0003	600,0

KPZ printers

Exemplary formats / Indicator KPZ 56-3/ KPZ 56-4 / KPZ 2-04-7 scale

Examples are the standard formats. Other formats are possible on request.

Example - format 1:

20.000	kg
7.975	kg
12.125	kg
13.380	kg

Example - format 2:

Ticket NO.	1	
Q'TY	40	PCS
APW	100	g
G/B	5.000	kg
T	1.000	kg
N	4.000	kg

Ticket NO.	2	
Q'TY	290	PCS
APW	100	g
G/B	30.000	kg
T	1.000	kg
N	29.000	kg

TOTAL TICKETS:	2
TOTAL Q'TY:	330 PCS

Example - format 3:

Date:	03-03-00	
Time:	09:04:43	
ID#:	123456789012345	
Part#:	543210987654321	
Ticket NO.	1	
Q'TY	40	PCS
APW	100	g
G/B	5.000	kg
T	1.000	kg
N	4.000	kg

Date:	03-03-00	
Time:	09:04:43	
ID#:	123456789012345	
Part#:	543210987654321	
Ticket NO.	2	
Q'TY	290	PCS
APW	100	g
G/B	30.000	kg
T	1.000	kg
N	29.000	kg

TOTAL TICKETS:	2
TOTAL Q'TY:	330 PCS

Example - format 4:

S/N	WT/kg	PCS
1.	20.000	3333
2.	20.000	3333
3.	8.000	1333
3/	TOTAL	Q'TY:
	7999	PCS

Example - format 5:

Date:	03-03-00	
Time:	09:04:43	
ID#:	123456789012345	
Part#:	543210987654321	
S/N	WT/kg	PCS
1.	20.000	3333
2.	20.000	3333
3.	8.000	1333
3/	TOTAL	Q'TY:
	7999	PCS

Printing formats

Indicator KPZ 56E-3 / KPZ 56E-4

Scale KPZ 2-04E-7

inkl. PT and Addition

standard format

NO.	1
G	276.7 kg
T	104.5 kg
PT	22.2 kg
N	150.0 kg
U/W	12 kg
PCS	13 pcs

NO.	2
G	176.7 kg
T	104.5 kg
PT	22.2 kg
N	50.0 kg
U/W	12 kg
PCS	4 pcs

=====	
T/N	2
T/W	200.0 kg
T/A	17 pcs

PT = Pretare

U/W = Unit Weight

PCS = Quantity

T/N = Total weighings

T/W= Total Netto weight

T/A= Total quantity

Indicator KPZ 51E-9-2

Example - format 1:

DATE:	03/03/2000
TIME:	09:04:43
TICKET NO.	01
NET:	+ 4.500 kg
GROSS:	+ 6.000 kg
TARE:	+ 1.000 kg
PRETARE:	+ 0.500 kg

DATE:	03/03/2000
TIME:	09:04:55
TICKET NO.	02
NET:	+ 5.500 kg
GROSS:	+ 6.000 kg
TARE:	+ 0.000 kg
PRETARE:	+ 0.500 kg

DATE:	03/03/2000
TIME:	09:05:35
TOTAL NO.	02
TOTAL NET:	+ 5.500 kg

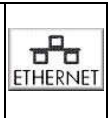

200305 00 N UK €



KPZ 2-11-3 **M**



KPZ 2-02-4 **M**



KPZ 2-03-10 **M** IP 65



KPZ 2-04-7 **M**



KPZ 2E-06S **M** **Ex**



KPZ 2114



KPZ 2082 Dual counting System



KPZ 1 **M** **Ex**



KPZ 1 B **M**



KPZ 2B **M**



KPZ 2S **M**



KPZ 2ECO **M**



Drive through Scale



KPZ 2D **M** **Ex**



KPZ 71-* **M** **Ex**

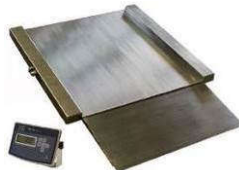

Stainless Steel DIN 1.4301, extrem solid and stable construction, IP 67, 68 and 69K



KPZ 72 **M** **Ex**



KPZ 73B



KPZ 73SDJ



KPZ 73 **M**



KPZ 74 **M**



KPZ 70 **M** weighing Forks



KPZ 39 Hydraulic Forklift scale



Crane scale **M**



Coil Scale



Animal scale **M**



Silo weighing





KPZ PC Software



Special models are our speciality!

Mobile KPZ scales



KPZ 71-7   
Many Option possible



Option KPZ 71-7



KPZ 71-8 
2.200kg / 200g



KPZ 71-9
2.200kg / 500g



KPZ 72 



KPZ 72, 2400mm, 3200kg



KPZ 73 



KPZ 73 SDJ 



KPZ 73 B 



KPZ 74 



Weighing forks Forklift truck scale



KPZ 39
Electronic – Hydraulic version



Touch sreen Indicator 7-Zoll



Scale for Coil's



German design and own EU production guarantees high quality.

Stainless steel Material : DIN 1.4301 / 1.4541 / 1.4404

KPZ-Waagen, Stainless steel scale and Indicator, IP 67/68/69K



Platform Scale KPZ 2N, Stainless steel, IP 67/68/69 K

Stainless steel Material : DIN 1.4301 / 1.4541 / 1.4404

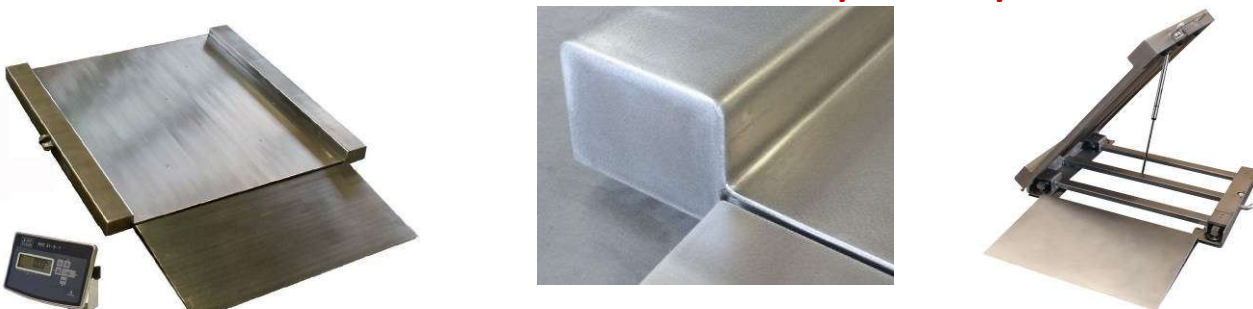

Low construction scale KPZ 2DN

Plain, top plate of platform made of one piece. IP 67/68/69K

Stainless steel Material : DIN 1.4301 / 1.4541 / 1.4404



**Pallet weigher Type: KPZ 71-7N
stainless steel DIN 1.430, IP 67/68/69K**

**Pallet scale KPZ 1N, IP 67/68/69K
Stainless steel - Material 1.4301**



**Bench Scale KPZ 2E-06, stainless steel DIN 1.430, IP 67/68, IP 69K
German design and own EU production guarantees high quality.**

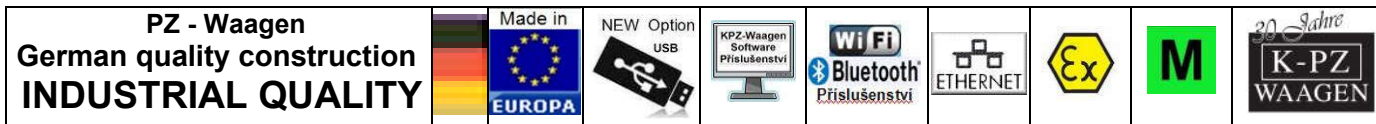

200305 00 N UK €



KPZ - Váhy, s. r. o.

Libošovice 76,
CZ 507 44 Libošovice

Tel.:

+420 736 622 710

+48 661 033 820

+420 493 571 111

email: / zander@kpzwaagen.de / kpz@kpz-vahy.cz

www.kpzwaagen.com