

KPZ 407E / Digital – crane scale M

Robust digital crane scale for industrial use / remote control included, approval possible
For continuous operation / Better quality: approved components !!!

Industrial version
Large LED display
Good readings
36 hours battery operation
Battery charging control
Good accuracy
Hold function
Overload safety ratio 600%
User friendly
2 Mini-remotes



These easy to handle, robust crane scale with internal battery, is completely ready for use. The price include the shakel and safety hook, and the 2 remote are also included in the price.

Electronic Display :Latest technology Micro-processor controlled designed, to meet even the most exacting requirements in industry. Guaranteed to the highest degree of accuracy and reliability. Built into aluminium housing for industrial use.

Operation of the units is through front push keypad or remote. Display : clear, 5 digit, 7 segment, red LED display, 25,4mm high. Precision : < 0,1%vde.

LED-indication for: Zero, Tare, Stability, Battery charging control, low Battery power, weight units selectable.

Function : On / Off switching by separate switch, Tare range : 100 % of full measuring range. Automatic and manual zero. HOLD function.

Remote control: 2 pcs reach up to. 30m. Function: switching ON/OFF, Zero, Tare, HOLD.

Power Supply: Rechargeable battery providing approx.36 hours, Charge indicator: signal indication by flashing LED which remains active at approx. 1 to 2 h before switching off. Automatic switching off function is possible.

Full recharge overnight via battery charger (included in price) connected to 230 V mains supply. Operating condition (temperature) : - 10 ° C to + 40 ° C.

Typ	Capacity	Div.	Unit weight	Approval possibility	Art.-No
407E/0003	300 kg	0,100 kg	10 kg	YES 	407E01500000
407E/0006	600 kg	0,200 kg	10 kg	YES 	407E03000000
407E/0015	1.500 kg	0,500 kg	14 kg	YES 	407E01500000
407E/0030	3.000 kg	1,000 kg	14 kg	YES 	407E03000000
407E/0050	5.000 kg	2,000 kg	19 kg	YES 	407E05000000
407/0075	7.500 kg	5,000 kg	28 kg	No	407075000000
407E/0075	7.500 kg	5,000 kg	39 kg	YES 	407E07500000
407/01000	10.000 kg	5,000 kg	35 kg	No	407100000000
407E/01000	10.000 kg	5,000 kg	49,5 kg	YES 	407E10000000
407/01500	15.000 kg	5,000 kg	42 kg	No	407150000000
407E/01500	15.000 kg	5,000 kg	49,5 kg	YES 	407E15000000

weights & measures certification (extra charge)

KPZ Factory first certification up to 500 kg, / single range	300PL0000500
KPZ Factory first certification from 550 kg up to 3.000 kg, / single range	300PL0003000
KPZ Factory first certification from 3.050 kg up to 10.000 kg, / single range	300PL0010000
KPZ Factory first certification from 10.000 kg up to 30.000 kg, / single range	300PL0030000

**24 months
 warranty**

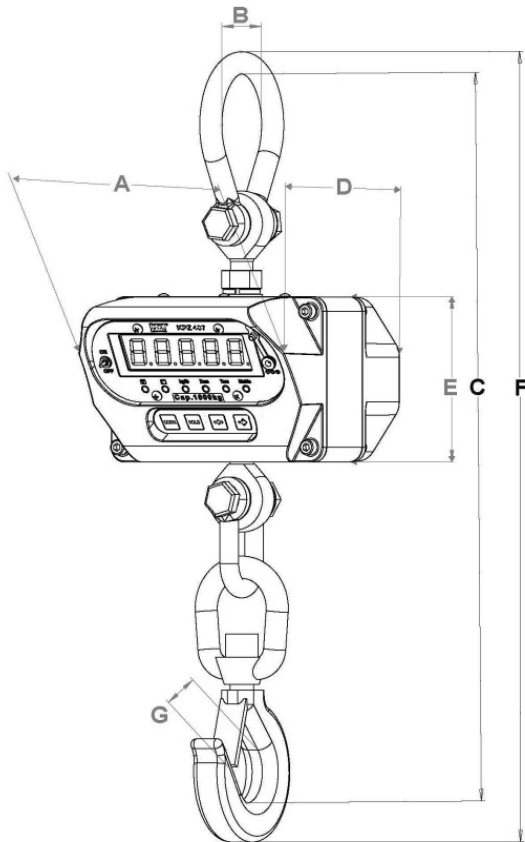

-  **Feuchteschutz IP66**
inkl. Druck-Membran-Ventil
-  **Rotierender Haken**
1,5-3t Version
-  **Schwenkbarer Licht-**
Displayschirm
-  **Robustes**
Alu-gehäuse

Dimension:

Typ	Capacity	A	B	C	D	E	F	G	Kg
KPZ 407(E)	1500kg	210	87	615	218	141	665	51	11
KPZ 407(E)	3000kg	210	87	615	218	141	665	51	11
KPZ 407(E)	5000kg	210	58	683	278	141	753	64	18
KPZ 407	7500kg	210	74	576	278	141	660	75	28
KPZ 407	10000kg	210	98	680	278	141	784	57	35
KPZ 407	15000kg	210	98	680	278	141	784	57	42
KPZ 407(E)	7500kg	210	68	808	278	141	890	75	39
KPZ 407(E)	10000kg	210	98	840	438	141	945	57	49,5
KPZ 407(E)	15000kg	210	98	840	438	141	945	57	49,5

**24 months
 warranty**

KPZ Crane Scale

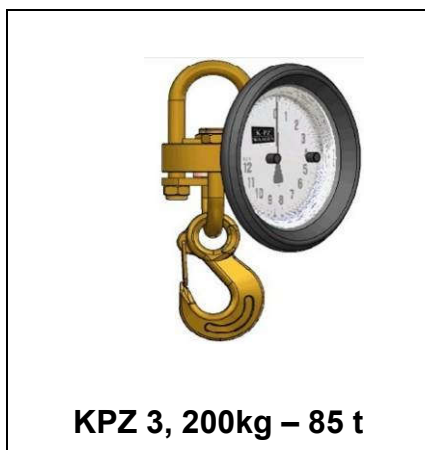

KPZ 3, 200kg – 85 t



KPZ 301, 200kg



BIG Display
for Crane Scale



KPZ 402, 300kg - 10 t



KPZ 402, 20 . 100 t



KPZ 407, 7,5 – 15 t 
IP 66



KPZ 406



KPZ 407E, 1,5 to 15 t
IP 66



KPZ 407FE 
Wireless data transfer

Crane scale type KPZ 3

Hydraulic version

Maintenance free, complete with top loading ring and self-locking hook

Crane scale for absolute continuous use. Accuracy: +/- 1% VDE, scale: White ground, black writing, clearly visible. With robust Plexischeibe, bordered with a rubber sleeve. Scales diameter: 160 mm. Until 5t: incl. Hook with safety flap and eyelet. Robust cast housing. Maintenance-free hydraulic principle. Security: 4 times the rated load carrying capacity: max 1.6 times capacity. With simple zeroing and tare. Font size: all scales 12mm. Storage case can be supplied as an option.

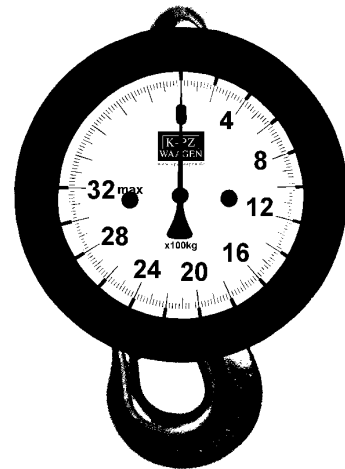

Typ	Kapazität	Teilung		Artikel-Nr.
KPZ 3	200 kg	1 kg		130020000000
KPZ 3	320 kg	2 kg		130032000000
KPZ 3	500 kg	2 kg		130050000000
KPZ 3	750 kg	5 kg		130075000000
KPZ 3	1250 kg	5 kg		130125000000
KPZ 3	2000 kg	10 kg		130200000000
KPZ 3	3200 kg	20 kg		130320000000
KPZ 3	5000 kg	20 kg		130500000000
KPZ 3	12500 kg	50 kg		131250000000
KPZ 3	25000 kg	100 kg		132500000000
KPZ 3	50000 kg	200 kg		135000000000
KPZ 3	85000 kg	500 kg		138500000000
portable case for KPZ 3				130000100000



**24 months
warranty**

KPZ 301 / mechanical Double-spring Crane scale

Capacity : 200 kg

Crane scale for simple and fast determination of weights in non-approved application.



Construction :

Robust and compact design with a low unit weight. The housing is made of cast aluminium, spray coated. Ring hook and load hook are manufactured in stainless steel. The scale is designed utilising a proven double-spring system. The dial is protected with a Flexible front display. If necessary after long periods of use, the scale may easily be adjusted through re-tension of the spring mechanism. Dial: white background, black figures, highly visible, with a Plexoglass cover framed in aluminium. Diameter of dial: approx. 19.5 cm, simple zero & tare adjustment.

Typ	Capacity	Div.	Dim. mm.	Approval possibility	Indicator	Art.-No
KPZ 301/200	200 kg	500 g		No	without	13010200000

**24 months
warranty**

Digital crane scale Type: KPZ 402

Solid Crane scales for industrial use / **SOLID** with all the **BENEFITS** !!

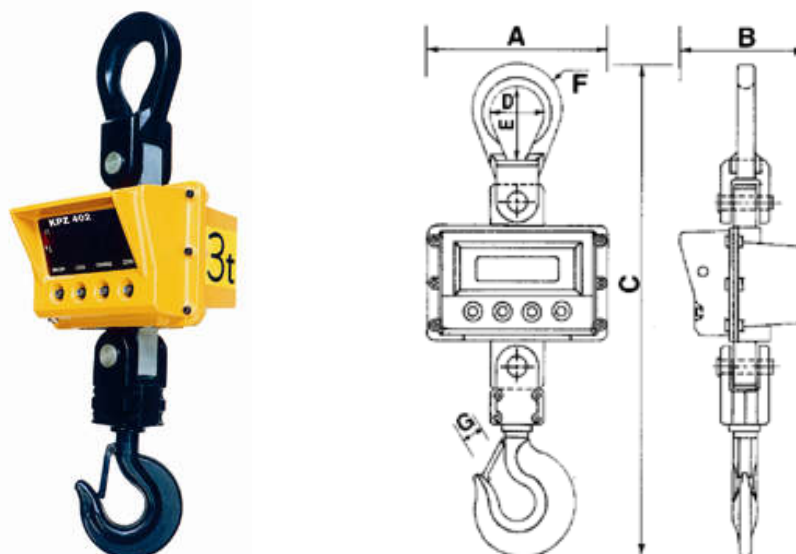

Weighing Range (kg) : 300, 600, 1.500, 3.000, 5.000, 10.000, 20.000, 30.000, 50.000, 100.000.

KPZ 402 is reliable, precise and easy to operate in every industrial environment, it has special load cell, solid and massive housing, integrated grip and rotary hook. Key function are protected from stroke in housing.

Technical data : Accuracy < 0.1% vdE, Operating temperature : - 10 ° C to + 40 ° C, LED display, in size range 1500kg = 25mm, from 3000 to 10,000kg = 30.5mm, from 20,000 to 30.000kg = 58,5mm.

Functions : KPZ 402 to 10t, zero setting, tare (to 100%), switch gross/net

Safety : crane scale KPZ 402 , has double load capacity and 6 times destructive loading.

Power Supply :Rechargeable battery providing approx.150 hours, control of charging status: two colour LED.

Control of accumulator: optic signal (flashing of indication about 9 hours before complete recharging of accumulator). Charging: charger 230V. Regulated charging process so there is no possibility of overcharging

Typ	Cap. t.	Div. kg	A	B	C	D	E	F	G	Kg	Eich	Art.-No.
KPZ 402	0,3	0,1	265	185	480	70	80	16	22	9,9	Nei	402000300
KPZ 402	0,6	0,2	265	185	480	70	80	16	22	9,9	Nei	402000600
KPZ 402	1,5	0,5	265	185	570	75	90	25	26	13,4	Nei	402001500
KPZ 402	3,0	1,0	305	245	800	90	120	40	40	26,4	Nei	402003000
KPZ 402	5,0	1,0	305	245	825	90	120	40	40	30,5	Nei	402005000
KPZ 402	10,0	5,0	305	255	925	110	150	40	45	41	Nei	402010000
KPZ 402	20,0	10,0	365	275	1105	150	175	60	85	82	Nei	402020000
KPZ 402	30,0	10,0	365	275	1135	170	200	70	105	126	Nei	402030000
KPZ 402	50,0	20,0	365	445	1210	200	200	75	105	161	Nei	402050000
KPZ 402	100,0	50,0	365	645	1680	220	230	105	110	265	Nei	402100000

Options KPZ 402 and KPZ 402F / accessoires / extra charge	Article-Nr.
Remote control for KPZ 402 Function: Zero, tare, net and gross weight, on/off	402000003000
Change-accu	402000004000
anti-heat shield	402000001000
Serial interface RS232	402007000000

**24 months
warranty**

Digital crane scale type: KPZ 402, Option: radio data transmission

KPZ-Váhy s.r.o. • Libošovice 76 • CZ507 44 Libošovice • GSM: 00420736622710 • Email: zander@kpzwaagen.de •
KPZ-Waagen - 30years - AFFORDABLE, ROBUST and GOOD !! www.kpzwaagen.com

We reserve the right to make technical modifications and price changes without prior notification. Warranty: The parts and components are warranted for two years from the date of delivery against defects in materials and workmanship, provided proper and normal use condition, excluding batteries and chargers.

KPZ 402FE Digitale Wireless cranescale Wireless data transfer from crane scale to indicator

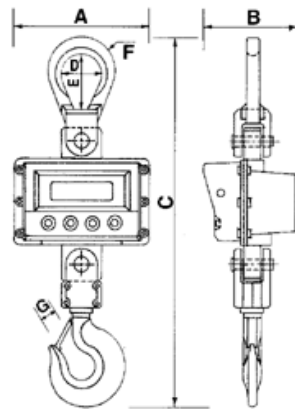

Robust radio crane scale
100% tarable
6 times the breaking load
Turning and swinging hook
Solid housing

Type	Capacity	Div		Indicator (Option)	Artikel-Nr.
KPZ 402F	1500 kg	500 g	Nein	<i>Pls select</i>	402F00150000
KPZ 402F	3000 kg	1 kg	Nein	<i>Pls select</i>	402F00300000
KPZ 402F	5000 kg	1 kg	Nein	<i>Pls select</i>	402F00500000
KPZ 402F	10000 kg	5 kg	Nein	<i>Pls select</i>	402F01000000

Indicator to KPZ 402F (More costs):	Artikel-Nr.
KPZ 51-26F Radio Indicator + Hand Display	5126F0000000
KPZ 51-27F Radio Indicator + Wall mounting possible	5127F0000000
KPZ 402F-GD Radio Big Display, Wall mounting possible	402F00004000
KPZ 51-28F Radio Indicator LCD 25mm with Roller Printer	5128F0000000



KPZ 51-26F



KPZ 51-28F



KPZ 402F-GD



KPZ 51-27F

KPZ 402 Option : Heat shield for crane scales



KPZ 402, 3 t, Heat shield



KPZ 402, 50 t, Heat shield

Option :
Remote controll



KPZ 407E / Digital – crane scale **M**

Robust digital crane scale for industrial use / remote control included, approval possible
For continuous operation / Better quality: approved components !!!

Industrial version
Large LED display
Good readings
36 hours battery operation
Battery charging control
Good accuracy
Hold function
Overload safety ratio 600%
User friendly
2 Mini-remotes



These easy to handle, robust crane scale with internal battery, is completely ready for use. The price include the shakel and safety hook, and the 2 remote are also included in the price.

Electronic Display :Latest technology Micro-processor controlled designed, to meet even the most exacting requirements in industry. Guaranteed to the highest degree of accuracy and reliability. Built into aluminium housing for industrial use.

Operation of the units is through front push keypad or remote. Display : clear, 5 digit, 7 segment, red LED display, 25,4mm high. Precision : < 0,1%vDE.

LED-indication for: Zero, Tare, Stability, Battery charging control, low Battery power, weight units selectable.

Function : On / Off switching by separate switch, Tare range : 100 % of full measuring range. Automatic and manual zero. HOLD function.

Remote control: 2 pcs reach up to. 30m. Function: switching ON/OFF, Zero, Tare, HOLD.

Power Supply: Rechargeable battery providing approx.36 hours, Charge indicator: signal indication by flashing LED which remains active at approx. 1 to 2 h before switching off. Automatic switching off function is possible.

Full recharge overnight via battery charger (included in price) connected to 230 V mains supply. Operating condition (temperature) : - 10 ° C to + 40 ° C.

Typ	Capacity	Div.	Unit weight	Approval possibility	Art.-No
407E/0003	300 kg	0,100 kg	10 kg	YES  M	407E01500000
407E/0006	600 kg	0,200 kg	10 kg	YES  M	407E03000000
407E/0015	1.500 kg	0,500 kg	14 kg	YES  M	407E01500000
407E/0030	3.000 kg	1,000 kg	14 kg	YES  M	407E03000000
407E/0050	5.000 kg	2,000 kg	19 kg	YES  M	407E05000000
407/0075	7.500 kg	5,000 kg	28 kg	No	407075000000
407E/0075	7.500 kg	5,000 kg	39 kg	YES  M	407E07500000
407/01000	10.000 kg	5,000 kg	35 kg	No	407100000000
407E/01000	10.000 kg	5,000 kg	49,5 kg	YES  M	407E10000000
407/01500	15.000 kg	5,000 kg	42 kg	No	407150000000
407E/01500	15.000 kg	5,000 kg	49,5 kg	YES  M	407E15000000
weights & measures certification (extra charge)					
KPZ Factory first certification up to 500 kg, / single range					300PL0000500
KPZ Factory first certification from 550 kg up to 3.000 kg, / single range					300PL0003000
KPZ Factory first certification from 3.050 kg up to 10.000 kg, / single range					300PL0010000
KPZ Factory first certification from 10.000 kg up to 30.000 kg, / single range					300PL0030000

24 months warranty

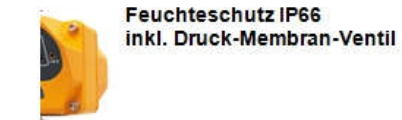
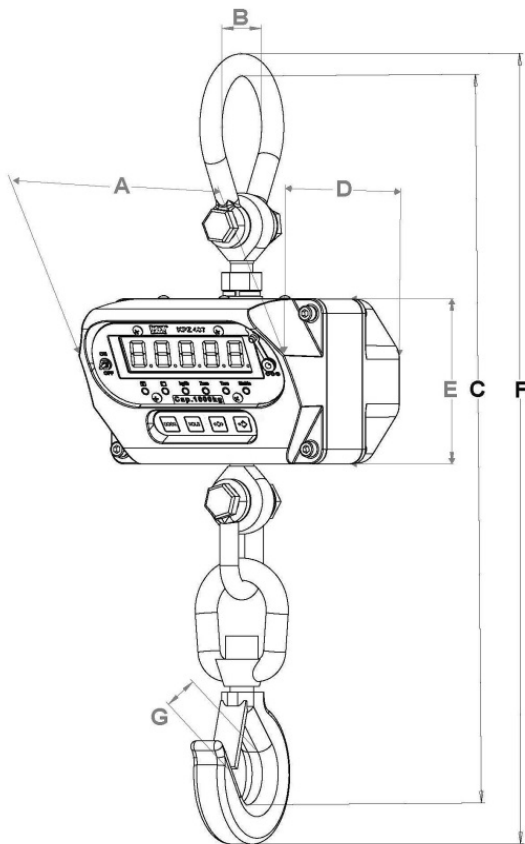

Dimension:

Typ	Capacity	A	B	C	D	E	F	G	Kg
KPZ 407(E)	1500kg	210	87	615	218	141	665	51	11
KPZ 407(E)	3000kg	210	87	615	218	141	665	51	11
KPZ 407(E)	5000kg	210	58	683	278	141	753	64	18
KPZ 407	7500kg	210	74	576	278	141	660	75	28
KPZ 407	10000kg	210	98	680	278	141	784	57	35
KPZ 407	15000kg	210	98	680	278	141	784	57	42
KPZ 407(E)	7500kg	210	68	808	278	141	890	75	39
KPZ 407(E)	10000kg	210	98	840	438	141	945	57	49,5
KPZ 407(E)	15000kg	210	98	840	438	141	945	57	49,5

24 months warranty

KPZ 406 / Digital – crane scale

Inexpensive version



KPZ 406, 1 – 10 t

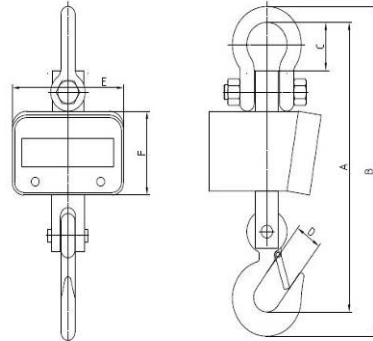

KPZ 406, 100 – 500 kg

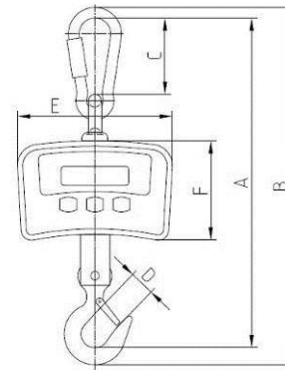

KPZ 406
20 – 50t



KPZ 406, Digital-Crane scale,

robust Industrial version with large stable push button, clear and easy readable LCD-Display, complete with hook/eye to hang up. **Basic function** : Zero setting, Tare setting up to 100 %, switch Net / Gross weight repeatedly, On/Off. **Power supply** : rechargeable Batteryoperation providing approx 100 h, 230 VAC Adapter is include the unit price, **Certification** : CE conform, but non approved for Retail use.

Typ	Capacity	Div.	Approval possibility	Art.-No
KPZ 406	200 kg	0,1 kg	No	406005000000
KPZ 406	300 kg	0,1 kg	No	406005000000
KPZ 406	500 kg	0,2 kg	No	406005000000
KPZ 406	1,0 t	0,5 kg	No	406010000000
KPZ 406	2,0 t	1,0 kg	No	406020000000
KPZ 406	3,0 t	1,0 kg	No	406030000000
KPZ 406	5,0 t	2,0 kg	No	406050000000
KPZ 406	10,0 t	5,0 kg	No	406100000000
KPZ 406	20,0 t	10,0 kg	No	406200000000
KPZ 406	30,0 t	10,0 kg	No	406300000000

Type	Capacity	Division	A	B	C	D	E	F	Art. nr	Own weight
KPZ 406	100 - 500 kg	200 g	330	360	77	22	147	100	406005000000	2 kg
KPZ 406	1 t	500 g	425	470	93	23	215	150	406010000000	4 kg
KPZ 406	2 t	1,0kg	450	510	75	35	190	130	406020000000	15 kg
KPZ 406	3 t	1,0 kg	450	510	75	35	190	130	406030000000	15 kg
KPZ 406	5 t	2,0 kg	525	605	90	40	190	130	406050000000	20 kg
KPZ 406	10 t	5,0 kg	590	690	115	47	190	130	406100000000	30 kg

Dimension: (all dimension in mm)

Value for Money

24 months
warranty

KPZ 407FE Digitale Wireless cranescale Wireless data transfer from crane scale to indicator.

Capacity from 300kg. up to 15t, non certified and also legal for trade, very robust industry designs, robust cast aluminium case,
Certification: EU type approval certificate class III, CE conform.

KPZ 51FE-41 indicator, inside a robust Steel case, 6-digit 20 mm high backlite LCD display with status symbols, large using keys, separate one/switch. Basic function: Zero, Tare, gross-/net switching. Over menu adjustable: Set point or limit value control.

Energy: rechargeable battery, by 230VAC

Extended functions and optional possibilities (surcharge):

Connection: Serial interface RS232, incl. data version format- and mode choice, Relay output of 3 switching points.

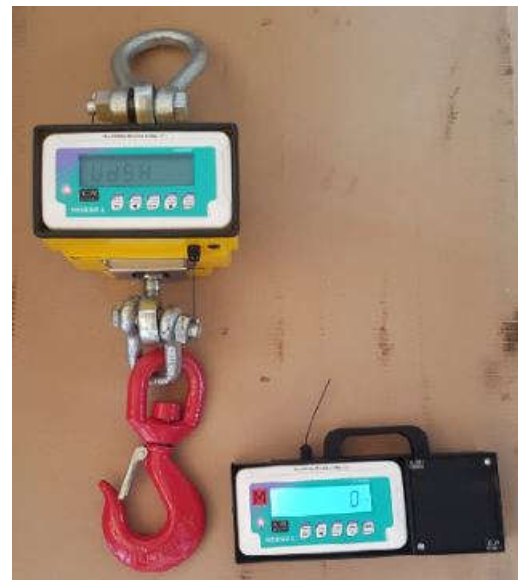

**24 months
warranty**

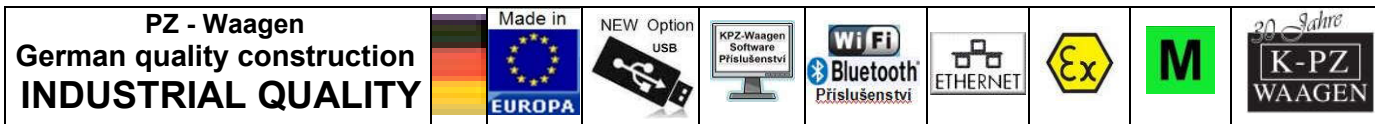

200305 00 N UK €

Special models are our speciality!

PZ - Waagen
German quality construction
INDUSTRIAL QUALITY

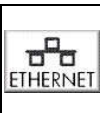

200305 00 N UK €

Mobile weighing | **M** **| Ex ATEX Conform**

Of course with valid OIML, class III, KPZ Factory first certification (Option) ! ! !

<p>Pallet Jack with scale</p>		
<p>Pallet Jack with scale Stainless Steel</p>		
<p>KPZ 72 / weighing system for electric stacker, installed in customer own Truck</p>		
<p>KPZ 73S / weighing system for lifting stacker, installed in customer own Truck</p>		
<p>KPZ 73B / drum lifter with scale</p>	<p>KPZ 74 / scissorlifts with scale</p>	<p>KPZ 75 / Fork- lift truck scale</p>
<p>KPZ 76-* / Fork- lift truck scale</p>		<p>Scale for Coil's</p>
<p>KPZ 39-1 KPZ 39-2 Hydraulic Forklift scales</p>		<p>KPZ 601/ barrow scale</p>

KPZ 71-7 | Capacity 2.200 kg | Div. : 100g , 200 g, 500g | accuracy: 0,02 %
German design and own EU production guarantees high quality.

KPZ Hand-cart/barrow scale type: KPZ 601

Compl. with indicator KPZ 51-16.
Steel powder painted construction
Capacity 150 kg, division 100 g; incl. battery and adapter.

Calibration protocol as an option. Price on request.



Type	Capacity	Division	Approval	Article-Nr.
KPZ 601	150kg	100g	No	601000000150

Options / accessories / extra charge	€/pcs	Article-Nr.
Printers: Options (extra cost) + costs for output RS 232		
Roller printer FAVORIT Plus,	On request	171023000000
serial interface / Setpoints: Options / extra costs		
Serial interface RS 232 C for KPZ 51-16-1		171307000000

Packing dimension	
Type	Packing dimension
KPZ 601	1400x800x500 mm

Special requirements for unique loading - please contact us for more information!

KPZ price includes complete scale with indicator.

. German design and own EU production guarantees high quality.

Special models are our speciality!



KPZ 71-9 / Palletweigher

Standard capacity: 2.200 kg Div. 500g / accuracy 0,05% on the weighing
Weights&measures | powder coating | good value for money | solid



Large LCD display 30 mm high
Display backlight
Large operating keys
Easy to operate
Large battery capacity
Battery : ca.60 hours operating time
Immediately ready for weighing



Option : Printer
KPZ 71-9 DR

German design and own EU production guarantees high quality. Mobile weighing Saved working time / simply use, take the Palletweigher, drive directly under the pallet or load, pump up, weighing and drive the load to the point of use.

Construction: high quality, for industrial use, solid and stable steel construction. Powder painted blue colour (RAL 5002), welded drawbar, robust forks. Safe, proven in industrial use hydraulics. Large rubber steering wheels Ø 200mm and polyurethan-tandem rolls. Wheels suspension guarantees stability and movement fluency, built in lubrication grease nipples guarantee long operating life of all movable construction parts. Indicator described below is built in a robust steel housing on height comfortable for operator. **Certification:** non approved version and EU type approved version for retail use, CE – conform.

Standard indicator: non approval version: KPZ 52-19, (Details and options for Indicator see data sheet)

Standard indicator: approval version: KPZ 52E-7 (Details and options for Indicator see data sheet)

Power supply : 6V battery, operating time up to 60 hours. Charger included. **Load cells:** High quality load cells KPZ 502E-3, IP 68, OIML C3; EC approval possible

Type	Fork mm	Capacity Kg.	Division	Approval Possible	Indicator	Article-Nr.
KPZ 71-9 S	450x1150	2.200 kg	500 g	No	KPZ 52-19	719SJ0502200
KPZ 71-9 S	560x1150	2.200 kg	500 g	No	KPZ 52-19	719SJ0002200
KPZ 71-9 S	560x1150	2.500 kg	1000 g	No	KPZ 52-19	719SJ0002500
KPZ 71-9 S	560x1150	3.000 kg	1000 g	No	KPZ 52-19	719SJ0003000
KPZ 71-9DR	560x1150	2.200 kg	500 g	No	KPZ 52-19	719SJDR2200
KPZ71-9S	560 x 800	2.200 kg	500 g	No	KPZ 52-19	719S00082200
KPZ71-9S	560x1800	2.200 kg	1000 g	No	KPZ 52-19	719S00182200
KPZ 71-9 S	560x1800	2.500 kg	1.000 g	No	KPZ 52-19	719S00182500
KPZ 71-9 SJ	560x2000	2.200 kg	1.000 g	No	KPZ 52-19	719S00202200
KPZ 71-9 SE	560x1150	2.000 kg	1.000 g	YES  M	KPZ 52E7	719S0020200E
KPZ 71-9 SE	560x1150	1000/2000 kg	500/1000 g	YES  M	KPZ 52E7	719SM020200E
KPZ 71-9 SL	690x1150	2.200 kg	500 g	No	KPZ 52-19	719S070002000
KPZ 71-9 SLE	690x1150	2.000 kg	1.000 g	YES  M	KPZ 52E7	719S0700200E

Option : Underdriving high 75 mm or 51mm

Packing, 1 KPZ 71-9 / Fork : 1150 mm	1600x650x1250 mm, 110 kg / packet on Pallet
Packing, 5 KPZ 71-9 / Fork : 1150 mm	2,30 x 0,60 x 1,00 m, 570 kg / packet in wooden Box

The built-in grease nipples ensure the longevity of all moving construction parts.

Technical data – standard specification: **KPZ 71-9 / Palletweigher**

Marking	1.1	Device		Palletweigher	1.1	
	1.2	Type		KPZ 71-9	1.2	
	1.4	Handling		Manual	1.4	
	1.5	Capacity	Q (t)	2,2	1.5	
	1.6	Loading gravity centre	c(mm)	578	1.6	
	1.8	forks surface length from wheel axle	x (mm)	950	1.8	
	1.9	Wheelbase	y (mm)	1200	1.9	
	Weights	2.1	Own weight	kg	110	2.1
		2.2	Axle load with load front / rear	kg	520/1550	2.2
2.3		Axle load without load front / rear	kg	55/34	2.3	
Wheels Undercarriage	3.1	Tyres (full, vulkollan, pneumatic, poliurethane)		Rubber/ Polyurethane	3.1	
	3.2	Front wheel dimension		200x40	3.2	
	3.3	Rear wheels dimension		80x70	3.3	
	3.5	Number of wheels		2/4	3.5	
	3.6	Front wheelbase	b ₁₀ (mm)	120	3.6	
	3.7	Rear wheelbase	b ₁₁ (mm)	390	3.7	
	Basic dimensions	4.4	Lift height	h ₃ (mm)	120	4.4
4.9		Drawbar height (in ready to ride position)	h ₁₄ (mm)	1225	4.9	
4.15		Height of lowered forks	h ₁₃ (mm)	87	4.15	
4.19		Length total without load	l ₁ (mm)	1570	4.19	
4.20		Length including forks surface	l ₂ (mm)	415	4.20	
4.21		Total width	b ₁ (mm)	560	4.21	
4.22		Fork teeth dimension	s/e/l (mm)	74x171x1155	4.22	
4.25		External forks width	b ₅ (mm)	560	4.25	
4.32		Ground clearance, central between axles	m ₂ (mm)	12	4.32	
4.33		Width of operating space for pallet 1000 x 1200	A _{st} (mm)	1880	4.33	
4.34		Width of operating space for pallet 800 x 1200	A _{st} (mm)	1760	4.34	
4.35		Turning radius	W _a (mm)	1310	4.35	
Performance		5.3	Lowering time with/without load	mm/s	0,09/0,02	5.3

The built-in grease nipples ensure the longevity of all moving construction parts.
Options? Ask us, we do almost everything possible for you

KPZ 71-8 / Palletweigher

(pallet truck with scale)

Standard capacity: 2.200 kg Div. 200g / accuracy 0,02% on the weighing

Weights&measures | powder coating | good value for money | solid

As Option possible : OIML Class  **M** SOLAS konform



Option : Printer KPZ 71-8

Indicator in steel housing
Easy to operate
Industrial quality
Tandem rollers
6 Digit 25 mm high LCD Display
100% tare / multi tare
Switch net and gross
Good read out
Option:
EC approval possibility: Class  **Printer**

Better quality !!! KPZ applies only EU approved components
Weighning Economy plus ! = Saved working hours

The built-in grease nipples ensure the longevity of all moving construction parts.

German design and own EU production guarantees high quality. Mobile weighing Saved working time / simply use, take the Palletweiger, drive directly under the pallet or load, pump up, weighing and drive the load to the point of use.

Construction: high quality, for industrial use, solid and stable steel construction. Powder painted yellow colour (RAL 1003), welded drawbar, robust forks. Safe, proven in industrial use hydraulics. Large rubber steering wheels Ø 200mm and polyurethan-tandem rolls. Wheels suspension guarantees stability and movement fluency, built in lubrication grease nipples guarantee long operating life of all movable construction parts. Indicator described below is built in a robust steel housing on height comfortable for operator. **Certification:** non approved version and EU type approved version for retail use, CE – conform.

Standard indicator: non approval version: KPZ 52-72 (Details and options for Indicator see data sheet)

Standard indicator approval version: KPZ 52E-7 (Details and options for Indicator see data sheet) **Power supply :** 6V battery, operating time up to 60 hours. Charger included. **Load cells:** High quality load cells KPZ 502E-3, IP 68, OIML C3; EC approval possible.

Typ	Fork Dim.mm	Capacity kg	Div.	Approval	Indicator:	Article – No.
KPZ 718SJ	450x1150	2200 kg	100 g	No	KPZ 5272	718S050002200
KPZ 718SJ	560x1150	2200 kg	100 g	No	KPZ 5272	718SJ00002200
KPZ 718SJ	560x1150	2200 kg	200 g	No	KPZ 5272	718SJ00002200
KPZ 718SMH	560x1150	1100/2200	100/200 g	No	KPZ 5272	718SMH002200
KPZ 718S	560x1150	2500 kg	1000 g	No	KPZ 5272	718S000002500
KPZ 718S	560x1150	3000 kg	1000 g	No	KPZ 5272	718S000003000
KPZ 718SL	690x1150	2.200 kg	500 g	No	KPZ 5172	718S07002200
KPZ 718SE	560x1150	2200 kg	1000 g	YES	KPZ 52E7	718S0000220E
KPZ 718SE	560x1150	1500 kg	500 g	YES	KPZ 52E7	718S0000150E
KPZ 718SE	560x1150	600 kg	200 g	YES	KPZ 52E7	718S0000060E
KPZ 718SME	560x1150	1100/2200	500g/1000 g	YES	KPZ 52E7	718SM000220E
KPZ 718SE	560x1150	2500 kg	1000 g	YES	KPZ 52E7	718S0000250E
KPZ 718SE	560x1150	3000 kg	1000 g	YES	KPZ 52E7	718S0000300E
KPZ 718SEL	690x1150	1100/2200	500g/1000 g	YES 	KPZ 52E7	718SM700220E

Option : Fork high 75 mm or 51 mm

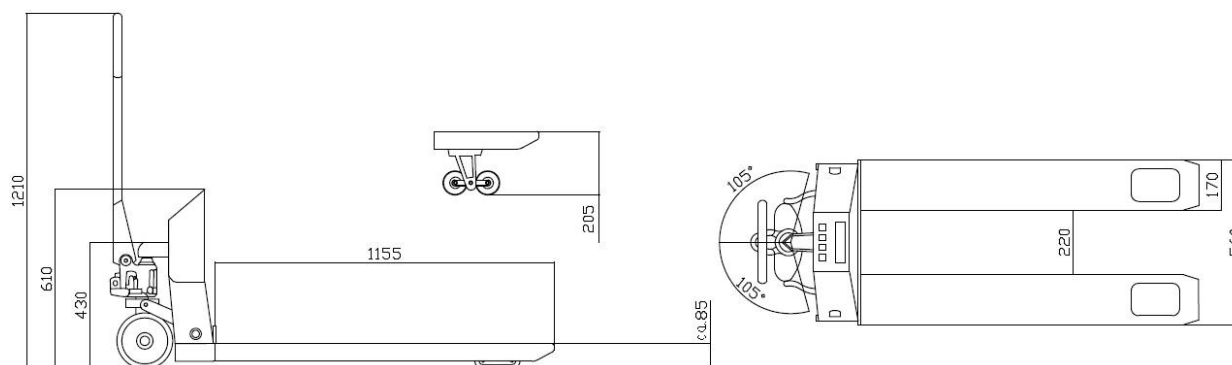

Type	Packing dimension
KPZ 71-9	153 x 65 x 125 cm, ca. 155 kg



Options? Ask us, we do almost everything possible for you
German design and own EU production guarantees high quality.

The built-in grease nipples ensure the longevity of all moving construction parts.



KPZ 71-7 / hand pallet truck with integrated scale  
solid and stable steel construction designed for weighing, powder painted
Capacity 2.000 kg | Division : 100g , 200 g, 500g | **accuracy: 0,02 %**
the world highest accuracy in mobile scales



Standard capacity: 2.200kg

Long exploitation period thanks to lubrication grease nipples

Easy to operate

Large Operating Keys



Industrial quality

Independent of Mains Power

Large Battery Capacity

6 Digit 25mm high LCD Display

100 % Tare

Good Read-out

High Accuracy

Back light

Tandem rollers

Options:

Printer

Weight Range: up to 3.000 kg

We will do for you almost everything

Options:

Narrow	Long/shorter	Wide	Turnable Indicator	Change-Battery	Wi-Fi
					

Better quality! KPZ applies only EU approved components

Mobile Weighing ? = Saved working hours & money!

The built-in grease nipples ensure the longevity of all moving construction parts.

EU-approval class  

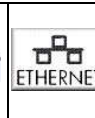

Typ	Fork Dim. mm	Capacity kg	Div. g	Approval possible	Indicator:	Article - No.
KPZ 717SJ	450x1150	1200 kg	100 g	No	KPZ 5272	717SH50002200
KPZ 717SJ	560x1150	1200 kg	100 g	No	KPZ 5272	717SH00002200
KPZ 717SJ	560x1150	2200 kg	100 g	No	KPZ 5272	717SH00002200
KPZ 717SJ	560x1150	2200 kg	200 g	No	KPZ 5272	717SJ00002200
KPZ 717SMH	560x1150	1100/2200	100/200 g	No	KPZ 5272	717SMH002200
KPZ 717S	560x1150	2500 kg	1000 g	No	KPZ 5272	717S000002500
KPZ 717S	560x1150	3000 kg	1000 g	No	KPZ 5272	717S000003000
KPZ 717SL	690x1150	2.200 kg	500 g	No	KPZ 5272	717S07002200
KPZ 717SE	560x1150	2200 kg	1000 g	YES	KPZ 52E7	717S0000220E
KPZ 717SE	560x1150	1500 kg	500 g	YES	KPZ 52E7	717S0000150E
KPZ 717SE	560x1150	600 kg	200 g	YES	KPZ 52E7	717S0000060E
KPZ 717SME	560x1150	1100/2200	500g/1000	YES	KPZ 52E7	717SM000220E
KPZ 717SE	560x1150	2500 kg	1000 g	YES	KPZ 52E7	717S0000250E
KPZ 717SE	560x1150	3000 kg	1000 g	YES	KPZ 52E7	717S0000300E
KPZ 717SE	690x1150	1100/2200	500g/1000	YES	KPZ 52E7	717S0700220E

Option : Fork high 75 mm or 51 mm

Construction : KPZ 71-7 mobile palletweigher: high quality, for industrial use, long exploitation **period**, very solid and stable steel construction, designed for weighing, powder painted, yellow color (RAL 1003), welded drawbar; strong forks made from 0.16"/4-mm steel plate. Safe, proven in industrial use hydraulics. Large, rubber steering wheels, diameter 7.87"/200 mm. Wheels suspension guarantees stability and movement fluency, built in lubrication grease nipples guarantee long operating life of all movable construction parts. Indicator described below is built in a robust steel housing on height comfortable for operator. **Indicator:** KPZ 52E-7 (possibility to deliver other one, indicated by a customer as an option). **Load cells:** High quality load cells KPZ 502E-3, IP 68, OIML C3; EC approval possible. **Certification:** EC approval possibility class III, declaration of conformity, approved version).

Power supply: 6V battery, operating time approx 36 hours, re-charging time max. 10 hours (normally carried out overnight). Charging device is included in unit price.

KPZ 52-7-2

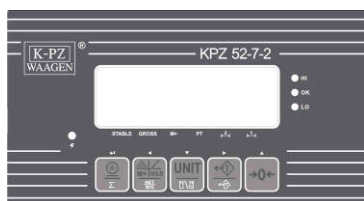

Features: Built in a stable, robust steel housing, Large user-friendly, membrane keyboard, 5 large control buttons. Easy to read, back-lit LCD - display, 6 digits, with 1.2"/30mm high digits.

Functions: Automatic and manual zero correction, Up to 100 % Tare, Gross - / Net switch, Minus indication, Piece counting by means of reference quantity selectable between 10, 20, 50, 100 and 200 pieces, Set point module HIGH-OK-LOW (i.e. two selectable weight values, color LED display), automatic self-test,

KPZ 52E - 7



Features: High resolution and fast weight display. Built in a stable, robust steel housing, user-friendly, dust and waterproof membrane keyboard, 4 large control buttons. LCD - display, 6 digits, 1.18"/30mm high digits, backlit. For approved weighing applications.

Functions: Automatic and manual zero correction →0←, Up to 100 % Tare ↔, Gross - / Net switch ^{NET}GROSS, Minus indication, Set point module HIGH-OK-LOW (ie two selectable weight values, LED display), Automatic selftest

Technical data: working temperature 14°F up to 104°F Dimensions. 10.16"x8.35"x4.57' (WxLxH)

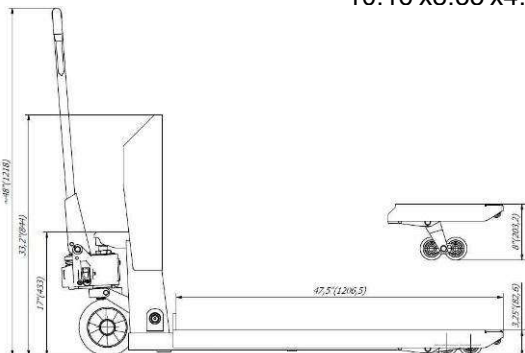

Pallet truck with integrated scale, Type KPZ 71-7 Favourite

Marking	1.1	Device		Palletweigher	1.1	
	1.2	Type		KPZ 71-7	1.2	
	1.4	Handling		Manual	1.4	
	1.5	Capacity	Q (t)	2,2	1.5	
	1.6	Loading gravity centre	c(mm)	578	1.6	
	1.8	forks surface length from wheel axle	x (mm)	950	1.8	
	1.9	Wheelbase	y (mm)	1200	1.9	
	Weights	2.1	Own weight	kg	142	2.1
		2.2	Axle load with load front / rear	kg	520/1550	2.2
2.3		Axle load without load front / rear	kg	55/34	2.3	
Wheels Undercarriage	3.1	Tyres (full, vulkollan, pneumatic, poliurethane)		Rubber/ Polyurethane	3.1	
	3.2	Front wheel dimension		200x40	3.2	
	3.3	Rear wheels dimension		80x70	3.3	
	3.5	Number of wheels		2/2 or 2/4	3.5	
	3.6	Front wheelbase	b ₁₀ (mm)	120	3.6	
	3.7	Rear wheelbase	b ₁₁ (mm)	390	3.7	
	Basic dimensions	4.4	Lift height	h ₃ (mm)	120	4.4
4.9		Drawbar height (in ready to ride position)	h ₁₄ (mm)	1225	4.9	
4.15		Height of lowered forks	h ₁₃ (mm)	87	4.15	
4.19		Length total without load	l ₁ (mm)	1570	4.19	
4.20		Length including forks surface	l ₂ (mm)	415	4.20	
4.21		Total width	b ₁ (mm)	560	4.21	
4.22		Fork teeth dimension	s/e/l (mm)	74x171x1155	4.22	
4.25		External forks width	b ₅ (mm)	560	4.25	
4.32		Ground clearance, central between axles	m ₂ (mm)	12	4.32	
4.33		Width of operating space for pallet 1000 x 1200	A _{st} (mm)	1880	4.33	
4.34		Width of operating space for pallet 800 x 1200	A _{st} (mm)	1760	4.34	
4.35		Turning radius	W _a (mm)	1310	4.35	
Performance		5.3	Lowering time with/without load	mm/s	0,09/0,02	5.3



German design and own EU production guarantees high quality.

The built-in grease nipples ensure the longevity of all moving construction parts.

Pallet truck with integrated scale, Type KPZ 71-7 Favourite - Construction

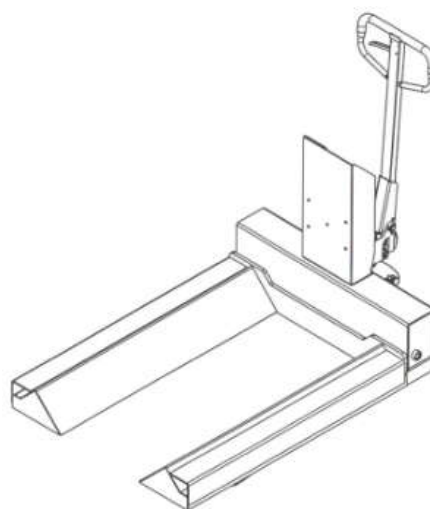
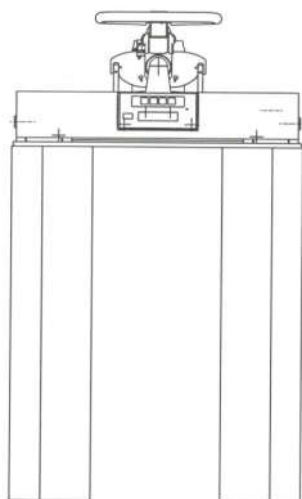
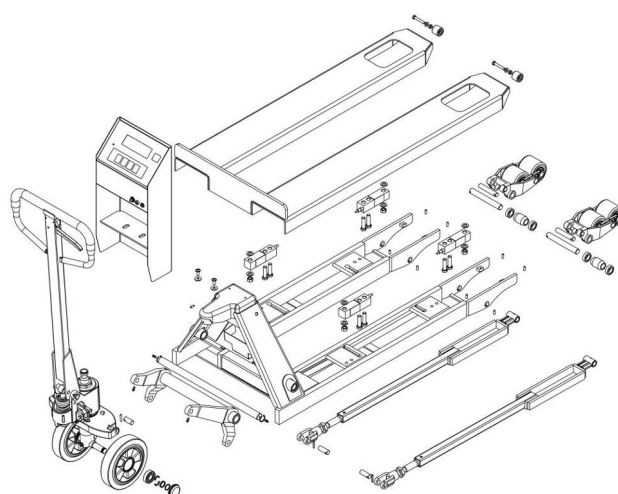
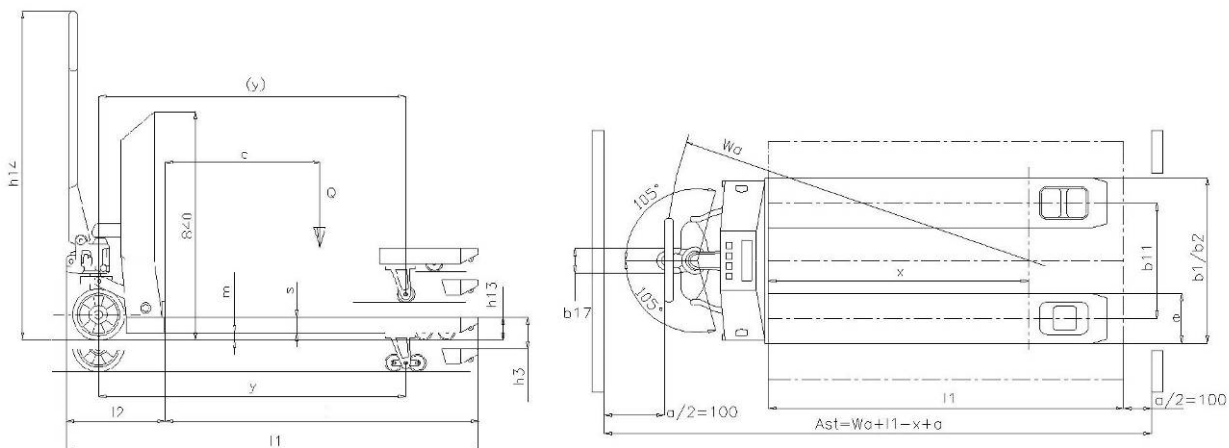

The built-in grease nipples ensure the longevity of all moving construction parts.

German design and own EU production guarantees high quality.



KPZ 71-7



Other capacity, division, option and dimension on request.

German design and own EU production guarantees high quality.

The built-in grease nipples ensure the longevity of all moving construction parts.





Options / accessories / extra charge	Article-Nr
Indicators: Options (extra cost)	
Indicator KPZ 52E-8 instead of KPZ 52-18	1252E8000000
Indicator KPZ 52E-8/1, <i>with pre tare and easy counting</i> instead of KPZ 52E-8	120030000000
Indicator KPZ 52E-8/1, <i>with pre tare and easy counting</i> instead of KPZ 52-18	12J030000000
Indicator KPZ 56E-3, <i>professional counting, addition, Tare input by hand,</i> instead of KPZ 52E-8	120324000000
Indicator KPZ 56E-3, <i>professional counting, addition, Tare input by hand,</i> instead of KPZ 52-18	120324000000
Indicator KPZ 52E-9-1, <i>Stainles steel housing (IP 67) easy counting</i> instead of KPZ 52E-8	1252E9100000
Indicator KPZ 52E-9-1, <i>Stainles steel housing (IP 67) easy counting</i> instead of KPZ 52-18	1252J9100000
Printers: Options (extra cost) + costs for output RS 232	
Roller printer FAVORIT Plus, for KPZ 51(E)-*,	120024000000
Printer DR 7	120039000000
Printer DR 7 with date & time	120039100000
Label printer and code printer type DR 2 for KPZ 56E-1, KPZ 51E-9-2	120038000000
Print design for DR 2 on request	204333100000
serial interface / Setpoints: Options / extra costs	
Serial interface RS232 C for KPZ 52E-8	1252E8000100
Serial interface RS232 C for KPZ 52-18	511830700000
Serial interface RS232 C for KPZ 52E-9-1	123071000000
Serial interface RS232 C for KPZ 51E-9-2	123072000000
Serial interface RS232 C for KPZ 56E-3 incl. PT and Addition	123080000000
Serial interface RS232 C for KPZ 56E-3 incl. RTC, w/out PT, w/out Addition	204300070000
Setpoints, 3 pcs for KPZ 52(E)-8 (more – OK – less)	120029001000
Setpoints, 3 pcs for KPZ 51E-9-2 (more – OK – less)	120029002000
Software "KPZ Smart Scale" STANDARD (incl. RS232 serial interface)	5S0001000000
Software "KPZ Smart Scale" PROFESSIONAL (incl. RS232 serial interface)	5S0005000000
Software "KPZ Smart Scale" PREMIUM (incl. RS232 serial interface)	5S0010000000
Wi-Fi Datatransfer	120005000000
Rechargeable battery version KPZ 51(E)-8, 56E-1, 51E-9-1, 51E-9-2	120040000000
Construction options	
Hand break	171701000000
Turning housing for indicator KPZ 51E-7, range 320°	17151E704400
Quicklifting for KPZ 71-7	171700313000
Load wheel / Nylon	171415000000
Load wheel / Nylon, tandem	171415100000
Steering wheel / Nylon	171417000000
Steering wheel / Polyurethane	171417100000
Other forks width, 480 mm to 680 mm	171311000000
Other forks length, 850 mm to 1550 mm	171310000000
Other forks length, 1600 mm to 1800 mm	171320000000
Other forks length, 2000 mm and longer	171502050000
Galvanized version, nickel-plated load cells	171412000000
Forks cover plate, stainless steel	171413200000
1 set of nickel- plated load cells KPZ 71-*	171413100000
Exchangable battery	171704000000
Factoryfirst certification (extra charge)	
For Capacity from 501 kg bis 3.000 kg	300PL0003000
For Capacity from 3.000 kg bis 10.000 kg	300PL0010000
For Capacity from 21 kg bis 200 kg Double range	300PLM000200
For Capacity from 201 kg bis 500 kg Double range	300PLM000500
For Capacity from .501 kg bis 3.000 kg Double range	300PLM003000

... please contact us for special requests!

The built-in grease nipples ensure the longevity of all moving construction parts.

. German design and own EU production guarantees high quality.



KPZ 71-7N / hand pallet truck with integrated scale  
stainless steel DIN 1.4301 / IP67/68+ IP 69K
Capacity 2.200 kg | Division : 100g , 200 g, 500g | accuracy: 0,02 %



weighing capacity up to **2.200 kg**
25 mm LCD – digits
backlight
100 % tare
easy readable

EU-approval class M  



Optionen:



KPZ 52E-9-2
Indicator



Build in
Thermo Printer



Build in Thermo Printer
IP65 housing



Footbreak



ATEX Indicator

Better quality !!! KPZ applies only EU approved components
Mobile Weighing! = Saved working hours !

German design and own EU production guarantees high quality.
The built-in grease nipples ensure the longevity of all moving construction parts.

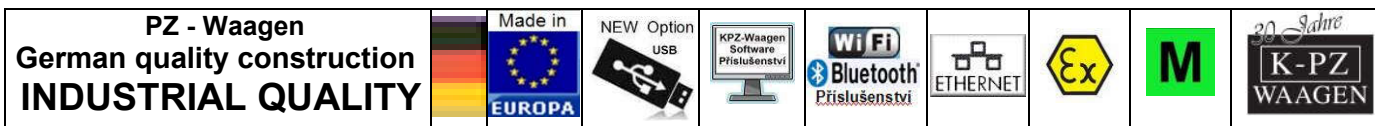

200305 00 N UK €

Solid and stable hand pallet truck scales series [KPZ 71-7N](#). **German design and own EU production guarantees high quality.** Designed as floor scales, for food and Chemical industrial weighing. High accuracy. Maintenance-free durable Stainless steel (DIN 1.4301 / IP67/68 / 69K) construction. High quality polishing standard (Glass bead blasted).

Construction: Robust, maintenance-free, welded steel construction, heavy duty design for food industrial use, **Stainless steel** weighing platform, Maintenance-free durable Stainless steel (DIN 1.4301 / IP67/68 / IP 69K)
Load cells: Robust, **stainless steel load cell**, IP68, OIML, with a high overload capacity. **Installation:** Adjustable leveling feet, designed for permanent or portable installations, 5m cable to connect digital indicator. **Options:** Custom sizes and capacities

Standard indicator: [KPZ 52E91](#), **For approved applications:** [KPZ 52E91](#), **Options for indicators:** Multi range, RS 232 serial interface, Various printers connection, Radio data transfer, WLAN, etc.. Internal battery

Approvals: OIML class III **M**, CE conform. **Power Supply** : 230 V mains, Power cord

Construction: complete stainless steel version of KPZ 71-7. High quality flat iron construction just constructed for weighing technic. steering wheels: **Nylon (Ø 200mm) fork wheels:** Tandem Nylon. weighingsystem: **4 high grad, stainless steel loadcells, Type KPZ 502E-3, IP68, EU approval certification class III, accuracy: 0,02%**, power supply: **Accu, charger incl.** **Certification:** EC approval possibility class III, Declaration of conformity, approved version.

hand pallet weigher KPZ 71-7N stainless steel [Material 1.4301](#)

Typ	Fork Dim. mm	capacity kg	Div. g	Approval possible	Indicator	Article – No.
KPZ 71-7N,	560x1150	2200	500	No	KPZ 52E91/IP67	717N00002200
KPZ 71-7NM,	560x1150	1500/2200	200/500	No	KPZ 52E91/IP67	717NM0002200
KPZ 71-7N,	560x1150	1500	200	No	KPZ 52E91/IP67	717NM0001500
KPZ 71-7N,	560x1150	2.500	200	No	KPZ 52E91/IP67	717N00001500
KPZ 71E-7N	690x1150	2.200 kg	500 g	No	KPZ 52E91/IP67	717N07002200
KPZ 71E-7N,	560x1150	600	200g	YES	KPZ 52E91/IP67	717N0000060E
KPZ 71E-7NM,	560x1150	1500	500g	YES	KPZ 52E91/IP67	717NM000150E
KPZ 71E-7N,	560x1150	1.500/2200	500/1000g	YES	KPZ 52E91/IP67	717NM000220E
KPZ 71E-7N,	560x1150	2200	1000g	YES	KPZ 52E91/IP67	717N0000220E
KPZ 71E-7N	690x1150	2.200 kg	1000 g	YES	KPZ 52E91/IP67	717N0700220E

Option : Fork high 75 mm or 51 mm

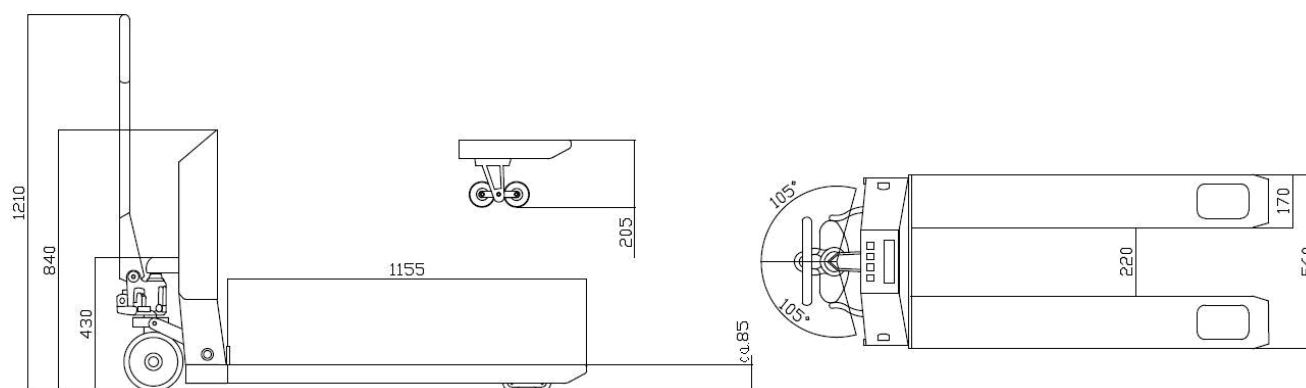

own weight approx. 150 kg.

Stainless steel DIN 1.4301 / 1.4541 / 1.4404 and IP 67/68 + IP 69K version possible

The built-in grease nipples ensure the longevity of all moving construction parts.



Options for the KPZ floor scales (stainless steel construction, material 1.4301)

Options / accessories / extra charge	Article-No.
Printers: Options (extra cost) + costs for output RS 232	
Roller printer FAVORIT Plus, for KPZ 52(E)-*,	120024000000
Label printer and code printer type DR 2 for KPZ 56E-3, KPZ 51E-9-2	120038000000
Print design for DR 2 on request	204333100000
Printer Info and Printout Example Starts from Page 142	

serial interface / Setpoints: Options / extra costs	Article-No.
Serial interface RS232 C for KPZ 52E-9-1	123071000000
Serial interface RS232 C for KPZ 51E-9-2	123072000000
Setpoints, 3 pcs for KPZ 51E-9-2 (more – OK – less)	120029002000
Software "KPZ Smart Scale" STANDARD (incl. RS232 serial interface)	5S0001000000
Software "KPZ Smart Scale" PROFESSIONAL (incl. RS232 serial interface)	5S0005000000
Software "KPZ Smart Scale" PREMIUM (incl. RS232 serial interface)	5S0010000000
Wi-Fi Datatransfer	120005000000
Rechargeable battery version KPZ 52E-9-1, 51E-9-2	120040000000

Konstruktions-Optionen	Article-Nr
320° Drehbares Schrankgehäuse zur KPZ 51E-7 Anzeigeelektronik	17151E704400
Changed Fork with, 480 mm to 680 mm	171311000000
Changed Forklong, 800 mm to 1150 mm	171310000000
Changed Forklong, 1200 mm bis 1550 mm	171320000000
Changed Forklong, 2000 mm and longer (ab 6 Wägezellen Konstruktion)	171502050000
Stainless Steel Fork	171413200000
Wechselakkuversion	171704000000

Factoryfirst certification (extra charge)	€/pcs	Artikel-Nr.
For Capacity from 0 kg to 21 kg		300PL0000020
For Capacity from 21 kg bis 200 kg		300PL0000200
For Capacity from 201 kg bis 500 kg		300PL0000500
For Capacity from 501 kg bis 3.000 kg		300PL0003000
For Capacity from 3.000 kg bis 10.000 kg		300PL0010000
For Capacity from 21 kg bis 200 kg Double range		300PLM000200
For Capacity from 201 kg bis 500 kg Double range		300PLM000500
For Capacity from 501 kg bis 3.000 kg Double range		300PLM003000
For Capacity from 3.000 kg bis 10.000 kg Double range		300PLM010000

... please contact us for special requests!

. German design and own EU production guarantees high quality.

The built-in grease nipples ensure the longevity of all moving construction parts.

Mobile Weighing = Saved working hours

Special models are our speciality!



KPZ 717EXS | ATEX, zone 1+2 | steel powder painted, stainless steel forks cover
Capacity 2.200 kg | Division : 500g | accuracy: 0,02 %

Option : EU-approval, class M



OPTION

 ATEX konform

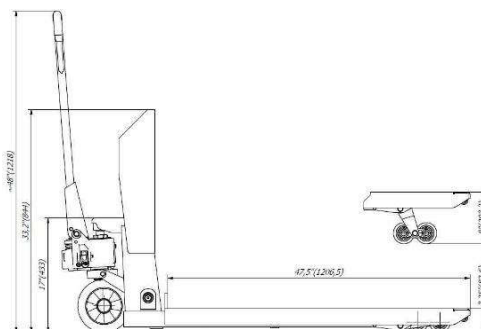

German design and own EU production guarantees high quality.

Solid and stable steel construction designed for weighing, in Steel, powder painted, stainless steel forks cover. **KPZ 71-7 Favorit, ATEX-Version, zone 1+2**, steel powder painted, stainless steel forks cover, conductive rubber steering wheels, conductive rubber tandem rollers. **Power supply:** build in battery, device charging via delivered charger outside the hazardous area. **Certification:** CE conform., EU type approved clas III is possible. Weighing range. Indicator : 52E-12EX

Typ	Fork Dim. mm	Capacity kg	Div. g	Approval possible	Indicator:	Article – No.
KPZ 717EXSZone2	450x1150	2200 kg	500 g	No	KPZ 52E12EX	717EXS2502200
KPZ 717EXSZone2	560x1150	2200 kg	500 g	No	KPZ 52E12EX	717EXS2002200
KPZ 717EXSZone2	560x1150	2200 kg	1000 g	YES	KPZ 52E12EX	717EXS200220E
KPZ 717EXSZone1	560x1150	2200 kg	500 g	No	KPZ 52E12EX	717EXS1002200
KPZ 717EXSZone1	560x1150	2200 kg	500 g	YES	KPZ 52E12EX	717EXS100220E
KPZ 717EXSZone1	690x1150	2200 kg	1000 g	No	KPZ 52E12EX	717EXS1702200

Option : Fork high 75 mm or 51 mm

Construction : KPZ 71-7 mobile palletweigher: high quality, for industrial use, long exploitation period, very solid and stable steel construction, designed for weighing, strong forks. Safe, proven in industrial use hydraulics. Large, rubber steering wheels, diameter 7.87"/200 mm. Wheels suspension guarantees stability and movement fluency, built in lubrication grease nipples guarantee long operating life of all movable construction parts. Indicator built in a robust steel housing on height comfortable for operator. **Indicator: KPZ 52E-12 EX** Stainless steel weighing terminal, IP 65, LED, Display 6 digits 20mm, 5 buttons, EU calibration certificate.

Function : Zero, 100% tare, / Gross/Net switching. **Power supply:** build in battery, device charging via delivered charger outside the hazardous area. Charging device is included in unit price. **Certification:** CE conform., EU type approved clas III is possible. Weighing range

.....pls contact us for special request !

German design and own EU production guarantees high quality.



KPZ 717EXN | ATEX, zone 1+2 | stainless steel DIN 1.4301

Capacity 2.200 kg | Division : 500g | accuracy: 0,02 %

Option : EU-approval, class 



ATEX Indicator



ATEX konform

German design and own EU production guarantees high quality.

Solid and stable hand pallet truck scales series **KPZ 71-7N**. (complet) Stainless Steel construction designed for weighing, in **food and Chemical** industry. High accuracy. Maintenance-free durable Stainless steel (DIN 1.4301 / IP67/Option : 68/69K) construction. High quality polishing standard (Glass bead blasted). Conductive Poly steering wheels and conductive tandem rollers. **Power supply:** build in battery, device charging via delivered charger outside the hazardous area. **Certification:** CE conform., EU type approved clas III is possible. Weighing range. Indicator : 52E-12EX

Typ	Fork Dim. mm	Capacity kg	Div. g	Approval possible	Indicator:	Article – No.
KPZ 717EXNZone2	450x1150	2200 kg	500 g	No	KPZ 52E12EX	717EXN2502200
KPZ 717EXNZone2	560x1150	2200 kg	500 g	No	KPZ 52E12EX	717EXN2002200
KPZ 717EXNZone2	560x1150	2200 kg	1000 g	YES 	KPZ 52E12EX	717EXN200220E
KPZ 717EXNZone1	560x1150	2200 kg	500 g	No	KPZ 52E12EX	717EXN1002200
KPZ 717EXNZone1	560x1150	2200 kg	500 g	YES 	KPZ 52E12EX	717EXN100220E
KPZ 717EXNZone1	690x1150	2200 kg	1000 g	No	KPZ 52E12EX	717EXN1702200

Option : Fork high 75 mm or 51 mm

Construction : KPZ 71-7 mobile palletweigher: high quality, for industrial use, long exploitation **period**, very solid and stable steel construction, designed for weighing, strong forks. Safe, proven in industrial use hydraulics. Large, rubber steering wheels, diameter 7.87"/200 mm. Wheels suspension guarantees stability and movement fluency, built in lubrication grease nipples guarantee long operating life of all movable construction parts. Indicator built in a robust steel housing on height comfortable for operator. **Indicator: KPZ 52E-12 EX** Stainless steel weighing terminal, IP 65, LED, Display 6 digits 20mm, 5 buttons, EU calibration certificate. Function : **Zero, 100% tare, / Gross/Net switching**. Power supply: **build in battery, device charging via delivered charger outside the hazardous area. Charging device is included in unit price.** Certification: **CE conform., EU type approved clas III is possible. Weighing range. Own weight approx. 150 kg.**

.....pls contact us for special request !

German design and own EU production guarantees high quality.



ATEX compliant KPZ mobile Weighing scale
stainless steel DIN 1.4301 / IP67/68+ IP 69K
EX zone 1+ 2 / EU-approval class M 



KPZ 76F

Typ KPZ 71-7NEX
stainless steel DIN 1.4301



KPZ 73BL



KPZ 717EX2SM



ATEX konform

Mobile weighing Saved working time / simply use, take the Palletweigher, drive directly under the pallet or load, pump up, weighing and drive the load to the point of use.

German design and own EU production guarantees high quality.



ATEX konform

Questionnaire on the implementation of safeguards EX according to ATEX

To check the performance of explosion-proof protection, it is necessary to accurately determine the explosion zone, temperature class and the group of devices according to their degree of hazard analysis. Please include the following information:

The division of zones:

Areas where there may be a dangerous atmosphere, have been divided into zones depending on the probability of the atmosphere EX. There are two kind of atmosphere-gaseous and dusty.

- Gaseous atmosphere 0/20 permanent, long-term or frequent threat (>1.000 h/a)
- 1/21 occasional threat (between 100 and 1.000 h/a)
- Dusty atmosphere 2/22 rare threat (<10 h/a).

Temperature class:

Electric resources Group II were divided into classes according to their maximum surface temperature. Analogically the gas division was made on the basis of different ignition temperatures. The highest permissible surface temperature of resources:

- T1=450° T2=300° T3=200° T4=135° T5=100° T6=85°

Group of devices:

Group I covers all resources, which are admitted to the excavations at risk of an explosive mixture of air and gases(e.g. mines)

Group II applies to areas "on the surface of the earth", for such industries as chemicals, petrochemicals, mills (dust), etc. For protection factor of ignition and compressive strength of the closure housing, another division was made on the basis of different ignition energy of gases (group of devices IIA to IIC).

- I typical gas, e.g. methane , ignition energy 280 μJ
- IIA typical gas, e.g. propane , ignition energy > 180 μJ
- IIB typical gas, e.g. ethylene , ignition energy 60...180 μJ
- IIC typical gas, e.g. hydrogen, ignition energy < 60 μJ.

= not available



PZ - Waagen
German quality construction
INDUSTRIAL QUALITY

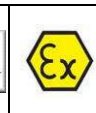
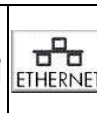

200305 00 N UK €

KPZ 72 / Weighing system for electrical Pallet Truck

Capacity depends on the client's supplied device / EU-approval class



Typ	Capacity kg	Division g	Indicator	Approval possible	Article No.
KPZ 72	600 to 1200	200 / 500	KPZ 5219	No	72000000X000
KPZ 72	2000 kg	1000g	KPZ 5219	No	72000000X000
KPZ 72	3000 kg	1000g	KPZ 5219	No	72000000X000
KPZ 72E	600 kg	500 g	KPZ 52E7	YES	7200000X00E
KPZ 72E	1500 kg	1000 g	KPZ 52E7	YES	7200000X00E
KPZ 72	3000 kg	1000g	KPZ 52E7	YES	7200000X000

Mobile Weighing = Saved working hours
German design and own EU production guarantees high quality.
Options? Ask, we do almost everything possible for you



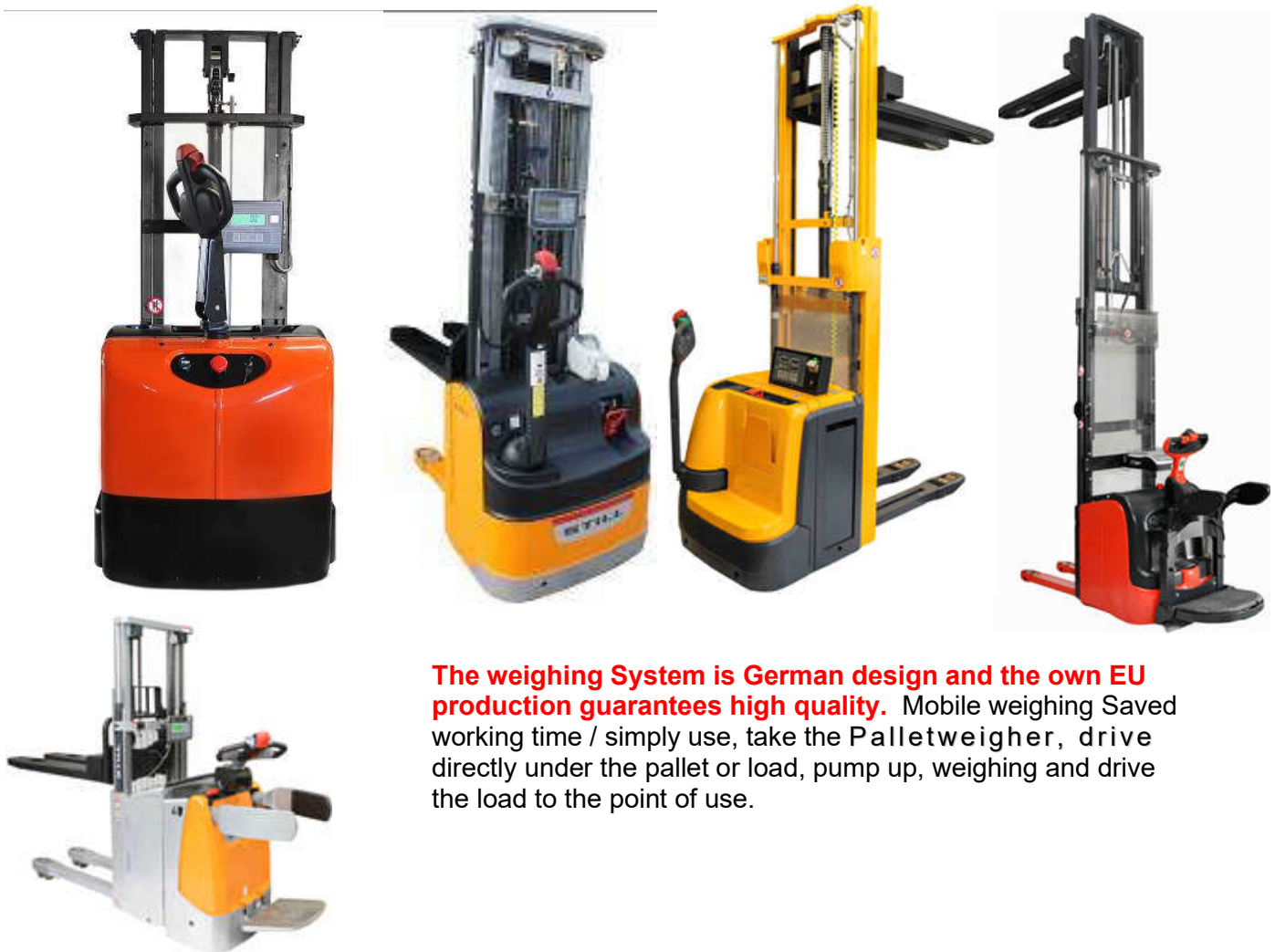

KPZ 73S / Weighing system mounted to electric lifting truck M

Capacity and Division depends on the client's supplied device / EU-approval class III



The weighing System is German design and the own EU production guarantees high quality. Mobile weighing Saved working time / simply use, take the Palletweigher, drive directly under the pallet or load, pump up, weighing and drive the load to the point of use.

Typ	Capacity kg	Division g	Indicator	Approval possible	Article No.
KPZ 73 Simplex	600 to 1600	1000g	KPZ5219	No	73S00000X00
KPZ 73 Doublex	600 to 1600	1000g	KPZ5219	No	73D00000X00
KPZ 73 Triplex	600 to 1600	1000g	KPZ5219	No	73T00000X00
KPZ 73 Simplex	600 to 1600	1000g	KPZ5219	YES 	73S00000X00
KPZ 73 Doublex	600 to 1600	1000g	KPZ5219	YES 	73D00000X00
KPZ 73 Triplex	600 to 1600	1000g	KPZ5219	YES 	73T00000X00

capacity depends to the client supplied unit / If more then 2m high we need Information.

Options? Ask us, we do almost everything possible for you

Mobile Weighing = Saved working hours



KPZ 73B / Mechanical+electronic drum lifter with integrated scale Barrel (mobile) scale type KPZ 73 B

Installed in a manual barrel lifting truck vehicle.
Complete with indicator KPZ 52E-9-1, able to work, incl. power supply and battery.
Construction: Steel powder painted

OPTION

ATEX konform



KPZ 73 B Standard



KPZ 73B L



KPZ 73B L / ATEX conform

Type	Lift height	Capacity	Division	Article-Nr
KPZ 73SB350	1,6 m	350 kg	500 g	73B000000350

Options? Ask us, we do almost everything possible for you

Mobile Weighing = Saved working hours



KPZ 73SDJ/ Mechanical lifter with Weighing system

Scope of delivery: mechanical Lifter, with build in KPZ-Waagen weighing system



The weighing System is German design and own EU production guarantees high quality.

Mobile weighing Saved working time / simply use, take the Palletweigher, drive directly under the pallet or load, pump up, weighing and drive the load to the point of use.

Construction: high quality, for industrial use, solid and stable steel construction. Powder painted blue colour, welded drawbar, robust forks. Safe, proven in industrial use hydraulics. Large rubber steering wheels Ø 200mm and polyurethan-tandem rolls. Wheels suspension guarantees stability and movement fluency, built in lubrication grease nipples guarantee long operating life of all movable construction parts. Indicator described below is built in a robust steel housing on height comfortable for operator. **Certification:** non approved version, CE – conform.

Standard indicator: non approval version: KPZ 52-19 (Details and options for Indicator see data sheet)

Power supply: 6V battery, operating time up to 60 hours. Charger included. **Load cells:** High quality load cells KPZ 502E-3, IP 68, OIML C3; EC approval possible

Typ	Lifting high	Capacity	Dívision	Approval possible	Indicator	Article No.
KPZ 73MSDJ160	1,6 m	1000 kg	500/1000 g	No	KPZ 5219	73SDJM161000
KPZ 73MSDJ250	2,5 m	1000 kg	500/1000 g	No	KPZ 5219	73SDJM251000
KPZ 73MSDJ300	3,0m	1000 kg	500/1000 g	No	KPZ 5219	73SDJM301000

Options? Ask us, we do almost everything possible for you
Mobile Weighing = Saved working hours



KPZ 74 / scissorlifts with scale

Weights&measures | powder coating | good value for money | solid

As Option possible : OIML Class



KPZ 74 semi electric scissor truck

The weighing System is German design and own EU production guarantees high quality.

Mobile weighing Saved working time / simply use, take the Palletweigher, drive directly under the pallet or load, pump up, weighing and drive the load to the point of use.

Construction: high quality, for industrial use, solid and stable steel construction. Powder painted blue colour, welded drawbar, robust forks. Safe, proven in industrial use hydraulics. Large rubber steering wheels Ø 200mm and polyurethan-tandem rolls. Wheels suspension guarantees stability and movement fluency, built in lubrication grease nipples guarantee long operating life of all movable construction parts. Indicator described below is built in a robust steel housing on height comfortable for operator. **Certification:** non approved version, CE – conform.

Standard indicator: non approval version: KPZ 52-19 (Details and options for Indicator see data sheet)

Standard indicator approval version: KPZ 52E-7 (Details and options for Indicator see data sheet). **Power supply :** 6V battery, operating time up to 60 hours. Charger included. **Load cells:** High quality load cells KPZ 502E-3, IP 68, OIML C3; EC approval possible

Typ	Lifting high	Capacity	Division	Approval possible	Indicator	Article No.
KPZ 74 SJ		1000 kg	500 g	No	KPZ 5219	74000001000
KPZ 74 SE		1000 kg	1000 g	YES	KPZ 52E7	7400000150E

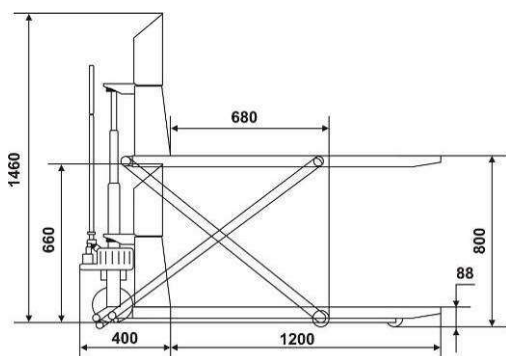

Dim. in mm

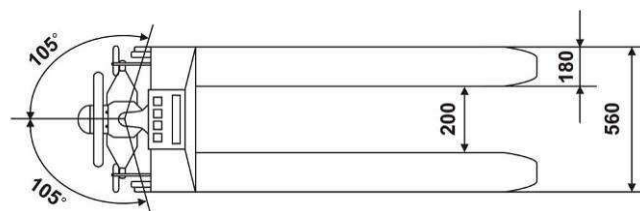

Options? Ask us, we do almost everything possible for you

German design and own EU production guarantees high quality.

Options / accessories / extra charge	Article-Nr
Indicators: Options (extra cost)	
Indicator KPZ 52E-8 instead of KPZ 52-18	1252E8000000
Indicator KPZ 52E-8/1, with pre tare and easy counting instead of KPZ 52E-8	120030000000
Indicator KPZ 52E-8/1, with pre tare and easy counting instead of KPZ 52-18	12J030000000
Indicator KPZ 56E-3, professional counting, addition, Tare input by hand, instead of KPZ 52E-8	120324000000
Indicator KPZ 56E-3, professional counting, addition, Tare input by hand, instead of KPZ 52-18	120324000000
Indicator KPZ 52E-9-1, Stainles steel housing (IP 67) easy counting instead of KPZ 52E-8	1252E9100000
Indicator KPZ 52E-9-1, Stainles steel housing (IP 67) easy counting instead of KPZ 52-18	1252J9100000
Printers: Options (extra cost) + costs for output RS 232	
Roller printer FAVORIT Plus, for KPZ 51(E)-*,	120024000000
Printer DR 7	120039000000
Printer DR 7 with date & time	120039100000
Label printer and code printer type DR 2 for KPZ 56E-1, KPZ 51E-9-2	120038000000
Print design for DR 2 on request	204333100000
serial interface / Setpoints: Options / extra costs	
Serial interface RS232 C for KPZ 52E-9-1	123071000000
Serial interface RS232 C for KPZ 56E-3 incl. PT and Addition	123080000000
Serial interface RS232 C for KPZ 56E-3 incl. RTC, w/out PT, w/out Addition	204300070000
Setpoints, 3 pcs for KPZ 51E-9-2 (more – OK – less)	120029002000
Software "KPZ Smart Scale" STANDARD (incl. RS232 serial interface)	5S0001000000
Software "KPZ Smart Scale" PROFESSIONAL (incl. RS232 serial interface)	5S0005000000
Software "KPZ Smart Scale" PREMIUM (incl. RS232 serial interface)	5S0010000000
Wi-Fi Datatransfer	120005000000
Rechargable battery version	120040000000

Factoryfirst certification (extra charge)	€/pcs.	Artikel-Nr.
For Capacity from 0 kg to 21 kg		300PL0000020
For Capacity from 21 kg bis 200 kg		300PL0000200
For Capacity from 201 kg bis 500 kg		300PL0000500
For Capacity from 501 kg bis 3.000 kg		300PL0003000
For Capacity from 3.000 kg bis 10.000 kg		300PL0010000
For Capacity from 21 kg bis 200 kg Double range		300PLM000200
For Capacity from 201 kg bis 500 kg Double range		300PLM000500
For Capacity from .501 kg bis 3.000 kg Double range		300PLM003000
For Capacity from 3.000 kg bis 10.000 kg Double range		300PLM010000

... please contact us for special requests!

Wireless data transfer from weighing forks to indicator in the cab.

Options? Ask us, we do almost everything possible for you

Mobile weighing ! Saved working hours and money! ! !

German design and own EU production guarantees high quality.



Forklift truck scale / Type: KPZ 75

KPZ-Váhy s.r.o. • Libošovice 76 • CZ507 44 Libošovice • GSM: 00420736622710 • Email: zander@kpzwaagen.de •
KPZ-Waagen - 30years - AFFORDABLE, ROBUST and GOOD !! www.kpzwaagen.com

We reserve the right to make technical modifications and price changes without prior notification. Warranty: The parts and components are warranted for two years from the date of delivery against defects in materials and workmanship, provided proper and normal use condition, excluding batteries and chargers.



KPZ 52F BLUETOOTH data transmission indicator, build in robust steel housing, 6 digits 25mm high backlit LCD display with status symbols. *Basic function:* zero setting, tare, gross/net switching, Low-Bat indication, Adjustable settings-setpoint required value. *Power supply:* 12VDC straight from the forklift. *Certificates:* CE-Konform, non approved version. Options (extra charge): *Communication:* Serial interface RS232, *Power supply:* battery version, incl.charger ;exchangeable battery version

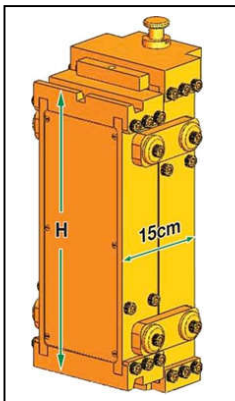

Accuracy: The patented linkages design offers maximum flexibility, which results in excellent accuracy with error within 0,1% of weighing capacity
Robust: The forklift scale is able to withstand head-on impact of more than 10 times weighing capacity
Compact: Each unit weights about 45 kg
Easy installation: Installing the scale onto the forklift is nothing more than installing forks. No screw, clamp or welding is required
Maximum visibility: Each unit of the scale is installed behind the fork. Therefore, there is no visual obstruction to the forklift operator to see loads and position forks for lifting.

Typ		Capacity kg	Division g	Aproval possible	Indicator	Article no
KPZ 75F	ISO 2A	0 do2500	1000	Ne	KPZ 52F1	75F0000X000
KPZ 75F	ISO 3A	2.500 do 4.500	2000	Ne	KPZ 5219	75F0000X000
KPZ 75F	ISO 4A	4.500 do 9.000	5000	Ne	KPZ 52F1	75F0000X000

Mobile weighing ! Saved working hours and money! ! !

KPZ 76/1 / Fork- lift truck scale / **Accuracy 0,05% on the weighing**
Weights&measures | powder coating | good value for money| solid
As Option possible : OIML Class **SOLAS konform**



German design and own EU production guarantees high quality. Mobile weighing Saved working time / simply use, drive directly under the pallet or load, lift up, weighing and drive the load to the point of use.

Accurate solid weighing system for fork lifts. Indicator is mounted on the left side of lift. On the right side of lift we mounted battery to power supply. Thanks to this construction was created weighing device on the fork lift, which can be used to any fork lift. Possibility of fast weighing without waste of time during transport, truck loading, filling BIG-BAG, production and other industrial processes. Inbuild battery – 60 hours operating time. We can optional deliver changing battery.

Typ	délka vidlic	Capacity kg	Division kg	Approval possible	Indicator	Obj. č.
KPZ 76-1	ISO 2A	600 - 2500	0,2 do 1,0	No	KPZ 5219	761002A00XX0
KPZ 76-1	ISO 3A	3.000 - 3500	1,0 do 2,0	No	KPZ 5219	761003A00XX0
KPZ 76-1	ISO 3A	4.000 - 5000	2,0	No	KPZ 5116	761003A00XX0
KPZ 76-1	ISO 4A	6000	2,0	No	KPZ 5219	761004A00600
KPZ 76-1	ISO 4A	8000	5,0	No	KPZ 5116	761004A00800
KPZ 76-1E	ISO 2A	2.000/2.500	0,2 do 1,0	yes	KPZ 52E7	761M02A00250
KPZ 76-1E	ISO 3A	3.000/3.500	2,0 do 5,0	yes	KPZ 52E7	761M03A00350
KPZ 76-1E	ISO 3A	4.000 do 5000	5,0	yes	KPZ 52E7	761003A00500
KPZ 76-1E	ISO 4A	6000	5,0	yes	KPZ 52E7	761004A00600
KPZ 76-1E	ISO 4A	8000	10,0	yes	KPZ 52E7	761004A00800

Options / extra costs		
Forks ISO 2B		76ISO02B0000
Forks ISO 3B		76ISO03B0000
Forks ISO 4B		76ISO04B0000

... please contact us for special requests!

German design and own EU production guarantees high quality.



Technical Detail :

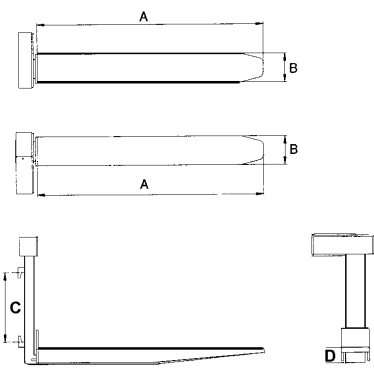

	KPZ 76*	KPZ 76*	KPZ 76*
	ISO 2A	ISO 3A	ISO 3A
Capacity :	600-2500 kg	3000-3500 kg	4000-5000 kg
Dimension	A	1150 mm	1150 mm
	B	134 mm	158 mm
	C	407 mm	508 mm
	D	62 mm	69 mm
Dead weight	140 kg	210 kg	260 kg

Other Capacity and Dimension on request

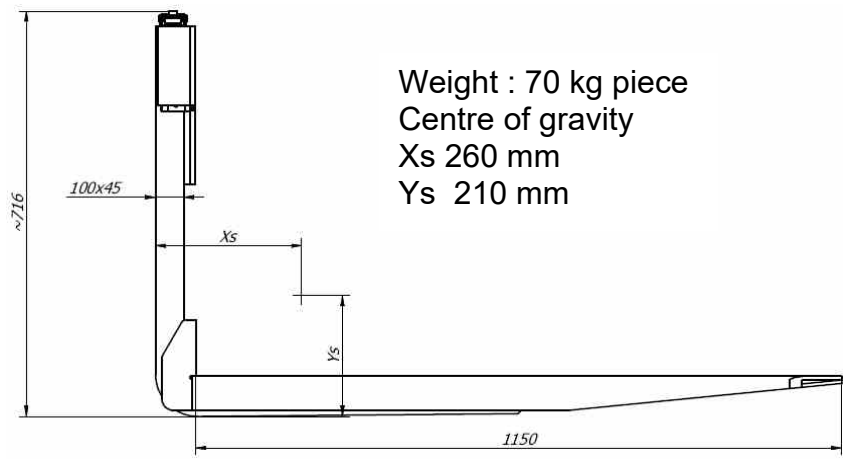

Weight : 70 kg piece
 Centre of gravity
 Xs 260 mm
 Ys 210 mm



Battery box KPZ 76

Options? Ask us, we do almost everything possible for you

Mobile weighing ! Saved working hours and money! ! !

**German design and own EU production guarantees high quality.
 Wireless data transfer from weighing forks to indicator in the cab.**



76F / Forklift truck scale / **Accuracy 0,05% on the weighing**
Wireless data transfer from weighing forks to indicator in the cab.
 As Option possible : OIML Class SOLAS conform



German design and own EU production guarantees high quality. Mobile weighing saved working time / simply use, drive directly under the pallet or load, lift up, weighing and drive the load to the point of use. Robust weighing system for forklift trucks with high accuracy. Robust, solid housing from ABS in operator cabine . User-Friendly keyboard protected by water and dust -proof foil, large functions keys, backlight LED indicator, 6 digit 25 mm high LCD-Display. Operating temperature -10°C do 40°C. Before the built-in is needed to define the dimensions and size of the planned tr signed for weighing pallets. Edit dimensions possible by prior arrangement.uck load. Standard is a set de

Typ	carriage	Capacity kg	Division kg	Approval possible	Indicator	Art. nr
KPZ 76F	ISO 2A	600 - 2500	0,2 do 1,0	No	KPZ 5119	76F002A00XX0
KPZ 76F	ISO 3A	3.000 - 3500	1,0 do 2,0	No	KPZ 5119	76F003A00XX0
KPZ 76F	ISO 3A	4.000 - 5000	2,0	No	KPZ 5119	76F003A00XX0
KPZ 76F	ISO 4A	6000	2,0	No	KPZ 5119	76F004A00600
KPZ 76F	ISO 4A	8000	5,0	No	KPZ 5119	76F004A00800
KPZ 76FE	ISO 2A	2.000/2.500	0,2 do 1,0	yes	KPZ 51E40	76FM02A00250
KPZ 76FE	ISO 3A	3.000/3.500	2,0 do 5,0	yes	KPZ 51E40	76FM03A00350
KPZ 76FE	ISO 3A	4.000 do 5000	5,0	yes	KPZ 51E40	76F003A00500
KPZ 76FE	ISO 4A	6000	5,0	yes	KPZ 51E40	76F004A00600
KPZ 76FE	ISO 4A	8000	10,0	yes	KPZ 51E40	76F004A00800

Options / extra costs

Forks ISO 2B		76ISO02B0000
Forks ISO 3B		76ISO03B0000
Forks ISO 4B		76ISO04B0000

Packing 1 piece KPZ 76F, FEM 2 A | wooden box 0,80 x 1,40 x 0,60 m, Weight : about 150 kg

Wireless data transfer from weighing forks to indicator in the cab.

Accuracy 0,05% on the weighing



Indicator for KPZ 76 F



KPZ 5119F Standard for KPZ 76F

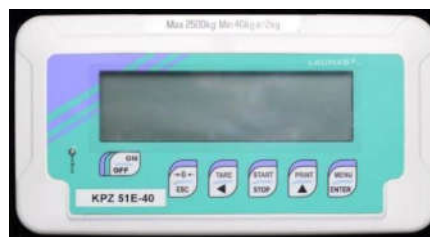

KPZ 51E40 pro KPZ 76FE

Technical Detail :

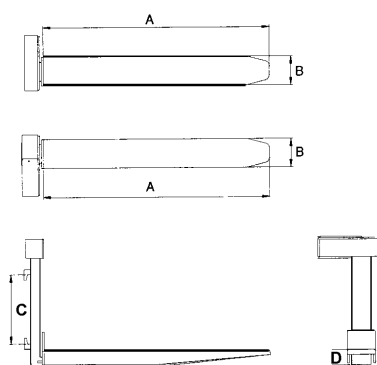

	KPZ 76*	KPZ 76*	KPZ 76*
	ISO 2A	ISO 3A	ISO 3A
Capacity :	600-2500 kg	3000-3500 kg	4000-5000 kg
Dimension	A	1150 mm	1150 mm
	B	134 mm	158 mm
	C	407 mm	508 mm
	D	62 mm	69 mm
Dead weight	140 kg	210 kg	260 kg

Other Capacity and Dimension on request

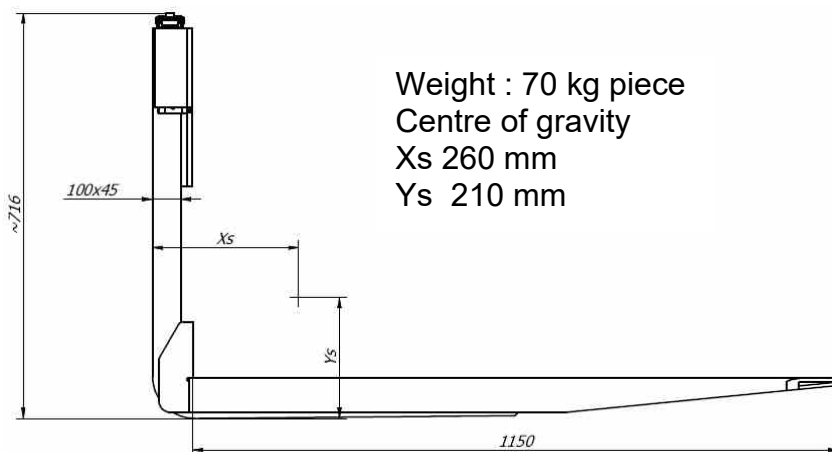

Weight : 70 kg piece
Centre of gravity
Xs 260 mm
Ys 210 mm

Wireless data transfer from weighing forks to indicator in the cab.



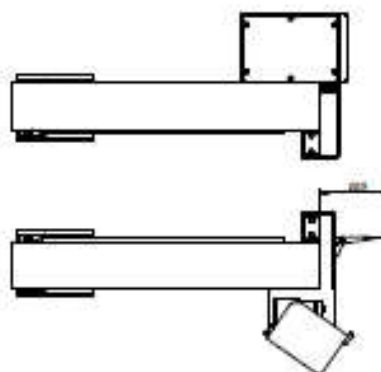
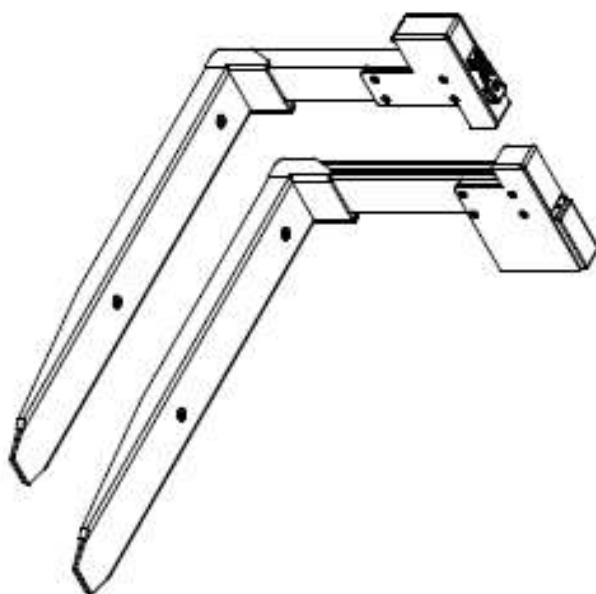
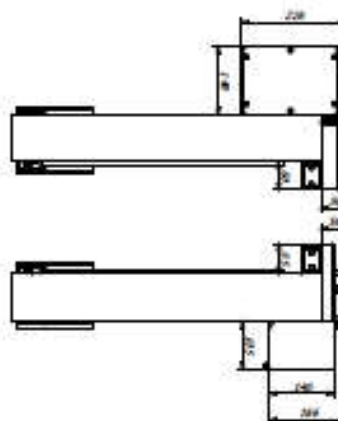
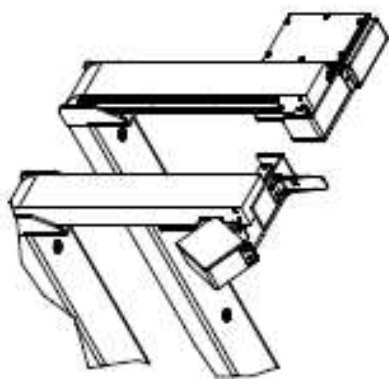
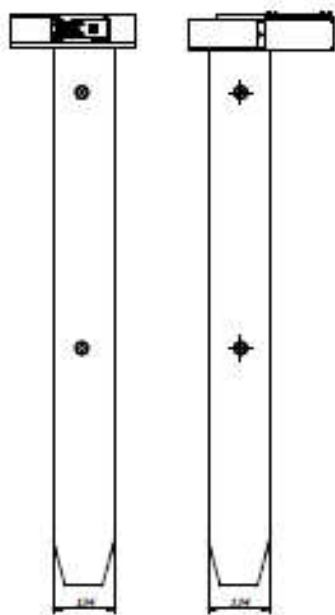

Options / accessories / extra charge	Article-Nr
Indicators: Options (extra cost)	
Delivery without Indicator KPZ 52E-8, REDUCED PRICE	1252E8OHNE00
Delivery without Indicator KPZ 52-18, REDUCED PRICE	125218OHNE00
Indicator KPZ 52E-8 instead of KPZ 52-18	1252E8000000
Indicator KPZ 52E-8/1, with pre tare and easy counting instead of KPZ 52E-8	120030000000
Indicator KPZ 52E-8/1, with pre tare and easy counting instead of KPZ 52-18	12J030000000
Indicator KPZ 56E-3, professional counting, addition, Tare input by hand, instead of KPZ 52E-8	120324000000
Indicator KPZ 56E-3, professional counting, addition, Tare input by hand, instead of KPZ 52-18	120324000000
Indicator KPZ 52E-9-1, Stainles steel housing (IP 67) easy counting instead of KPZ 52E-8	1252E9100000
Indicator KPZ 52E-9-1, Stainles steel housing (IP 67) easy counting instead of KPZ 52-18	1252J9100000
Printers: Options (extra cost) + costs for output RS 232	
Roller printer FAVORIT Plus, for KPZ 51(E)-*,	120024000000
Printer DR 7	120039000000
Printer DR 7 with date & time	120039100000
Label printer and code printer type DR 2 for KPZ 56E-1, KPZ 51E-9-2	120038000000
Print design for DR 2 on request	204333100000
serial interface / Setpoints: Options / extra costs	
Serial interface RS232 C for KPZ 52E-9-1	123071000000
Serial interface RS232 C for KPZ 56E-3 incl. PT and Addition	123080000000
Serial interface RS232 C for KPZ 56E-3 incl. RTC, w/out PT, w/out Addition	204300070000
Setpoints, 3 pcs for KPZ 51E-9-2 (more – OK – less)	120029002000
Software "KPZ Smart Scale" STANDARD (incl. RS232 serial interface)	5S0001000000
Software "KPZ Smart Scale" PROFESSIONAL (incl. RS232 serial interface)	5S0005000000
Software "KPZ Smart Scale" PREMIUM (incl. RS232 serial interface)	5S0010000000
Wi-Fi Datatransfer	120005000000
Rechargeable battery version	120040000000

Factoryfirst certification (extra charge)	€/pcs.	Artikel-Nr.
For Capacity from 0 kg to 21 kg		300PL0000020
For Capacity from 21 kg bis 200 kg		300PL0000200
For Capacity from 201 kg bis 500 kg		300PL0000500
For Capacity from 501 kg bis 3.000 kg		300PL0003000
For Capacity from 3.000 kg bis 10.000 kg		300PL0010000
For Capacity from 21 kg bis 200 kg Double range		300PLM000200
For Capacity from 201 kg bis 500 kg Double range		300PLM000500
For Capacity from .501 kg bis 3.000 kg Double range		300PLM003000
For Capacity from 3.000 kg bis 10.000 kg Double range		300PLM010000

... please contact us for special requests!

Wireless data transfer from weighing forks to indicator in the cab.

Options? Ask us, we do almost everything possible for you

Mobile weighing ! Saved working hours and money! ! !

German design and own EU production guarantees high quality.



KPZ 39-* / Hydraulic-electronic scales for forklift



Transport and weighing in one operation !!!

KPZ 39-* / hydraulic Forklift scales

Hydraulic – maintenance free– robust

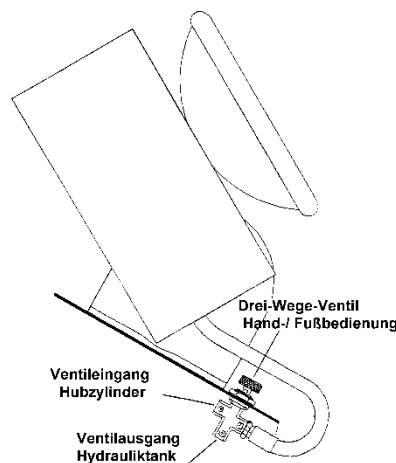
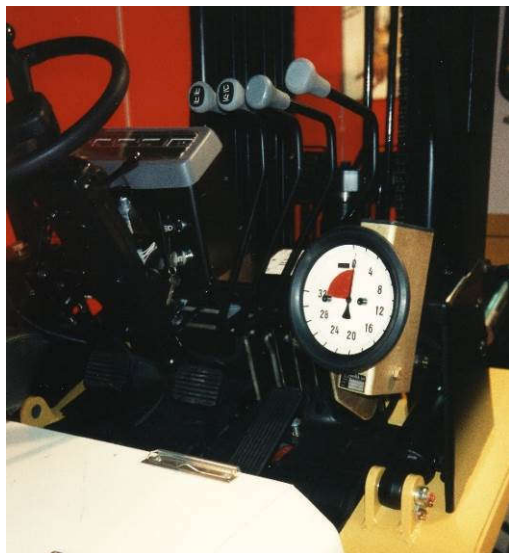

The weight indicator KPZ 39 has been specially developed for the robust forklift operation. This weight indicator has already proven itself in many of our customers in a tough industrial environment.

Generally, many forklifts may be equipped with the weight indicator KPZ 39. Self-assembly on every forklift is easily possible.

We supply the weight display type KPZ 39 in few different indicator scale, so no special adjustment in the type of truck is needed. This weight display can be used for all types of forklifts and forklift capacities. Moreover, the same weight indicator easily can be converted using the attached scale on any other truck in your fleet.

This weight indicator is connected to the hydraulic system of your forklift. The weighing process is launched by pressing a special valve (manually or by foot). The scale works only as long as the valve is open. The zero / tare - suppression is quickly and easily possible with the rotary dial.

Technical description:

Accuracy : 1 % for final load for systems using pressure from 120 up to 250 bar.

(other on request) Scales diameter: 160 mm, display: white background, black 12 mm high digits, easy to read.

The weight display consists of a robust cast housing with a plexiglas enclosed in a rubber boot. It is a maintenance-free hydraulic rule.

The easy assembly and adjustment is possible on site with some measures. You must assembly only 2 short hydraulic hoses. First as connecting the cylinder for switching valve. Second from switching valve to the hydraulic tank. The valve has ¼ " thread..

Device	Capacity	Division	Artikel-Nr.
KPZ 39	1000kg	2kg	1390010000
KPZ 39	1500kg	5kg	1390015000
KPZ 39	2000kg	5kg	1390020000
KPZ 39	2500kg	10kg	1390025000
KPZ 39	3000kg	10kg	1390030000
KPZ 39	5000kg	10kg	1390050000

Warranty: 24 months for flawless quality of materials and workmanship, proper and normal use provided. Excluding batteries and chargers.

We reserve the right to make technical modifications without prior notification / price net EXW / shipping cost on request

Mobile weighing ! Saved working hours and money! ! !

KPZ 39-1 / Oil pressure weighing system for Forklift

Electronic - Hydraulic – maintenance free– robust



Every fork truck can in principle be equipped with the weight indicator KPZ 39-1, an additional do it your selv assembling at every fork truck is easily possible. The weight indicator KPZ 39- 1 has extra been developed for the rugged fork truck operation in the hardest industry input.

Principle :

The KPZ 39 - 1 measures the pressure in the hydraulic system of the lift truck and translates this into an indication of the weight on the forks. Since the measuring system is not physically strained, there is no wear. For the capacity from 0 to 1500 kg and 0 to 6000 kg with the standard oil pressure of 150 to 600 Bar, the weighing system is allready pre adjusted according to the standard oil pressure of 150 to 600 Bar.

The final adjustment with approved weight is easy made. Option for oil pressure more then 600 Bar on request.

The installation is very easy. A T-coupling is installed on the hydraulic lead, onto which the pressure sensor is mounted. The KPZ Sensor has a 1/4" - external thread for the Capacity from 1500 kg up to 6000 kg. Attention the T-coupling is not inc. the price. The KPZ – Indicator model KPZ 52-19 shows the weight.

Power supply : 8x1,5V AA Battery build in the indicator housing. Battery autonomy ca. 100 hours.

Option : 12-28 Volt DC direct from the Forklift possible.

Option : 12-28 Volt DC direct from the Forklift possible.

Option for Indicator : different types, also with stainlees housing like picture possible.

Typ	Capacity kg	Division kg	Možnost úř. ověření	Indicator	Artikel-Nr.
KPZ 39-1	0 – 1500kg	10 kg	No	KPZ 5219	1391001500
KPZ 39-1	0 – 3000kg	20 kg	No	KPZ 5219	1391003000
KPZ 39-1	0 – 6000kg	50 kg	No	KPZ 5219	1391006000
KPZ 39-1	0 - 20000kg	100 kg	No	KPZ 5219	1391020000



KPZ 39-3 / Hydraulic-electronic scales for forklift
Electronic - Hydraulic – maintenance free– robust



KPZ 39-3 weighing system's operation principle is based on measuring the working machine's hydraulic cylinder pressure. Pressure transmitter reading is automatically scaled to weighing information (kg's or lbs.) and displayed on the operating panel.

MAIN FEATURES:The weighing information can be shown as GROSS or NET weight. The operating device is equipped with internal memory which enables saving to different memory categories. Total weighing information is saved into the memory after powering down. A timestamp is stored to every saved measurement. Indicator and measuring block is set to oil pressure up to 100 Bar.

TECHNICAL DATA: Display dimension: 150x90x25mm, Display device IP-class IP40, Pressure sensor IP-class IP67, Operating voltage 8-30VDC, Pressure sensor range (Dynamic Block) 0 – 100 bar, Operating temperature: 0°C - +40°C, Storage temperature -30°C - +40°C, Power consumption backlight on: < 2W, Power consumption backlight off: <350mW, Power consumption while weighing with Dynamic Block: 12W, Total power consumption in standby mode: <250mW, Non approved version only.

Weighing tolerance: 0,2%

Weighing systems for higher oil pressure are possible on request.

Typ	Capacity Bar	division kg	Art.-no
KPZ 39-3 up to 100 Bar.	100Bar	2 kg	39300000000

Options / accessories / extra charge	Article-Nr.
Options / extra costs	
Option : up to 250 Bar.	3930000B250
Option : up to 400 Bar.	3930000B400

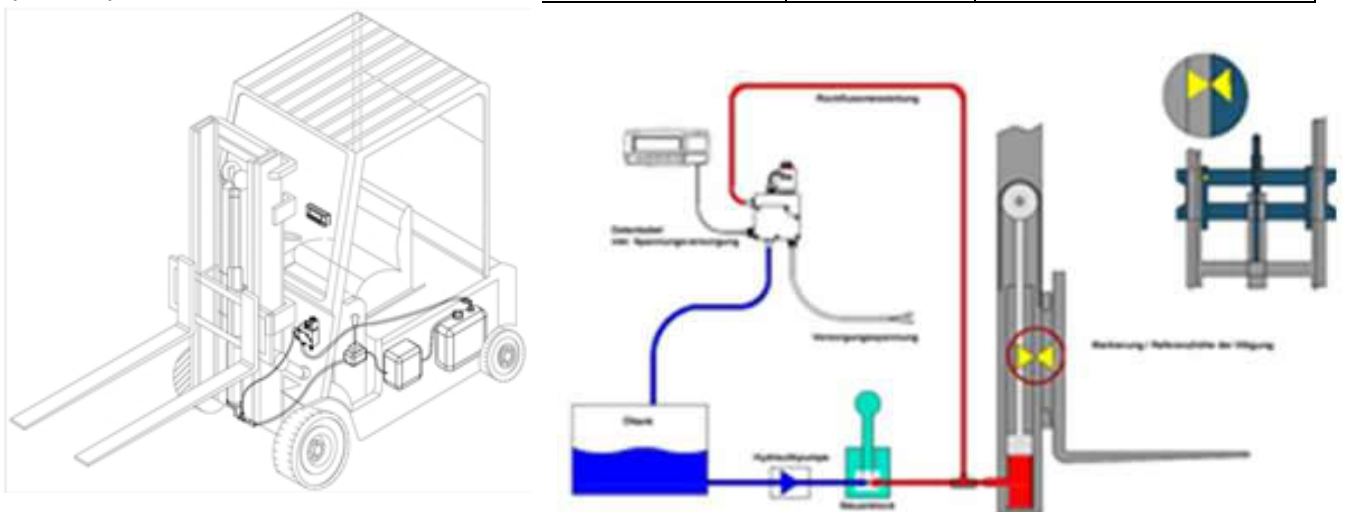

KPZ 2 A / Platform scale for animals



We also offer many types of custom design, depending on customer needs.



KPZ 2 ECO



KPZ 2-11-4

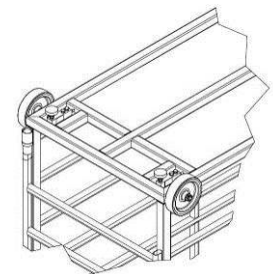
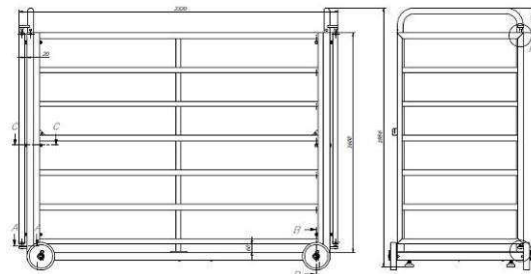

KPZ 2A, low profile Animal platform scale, dim 920 x 2200 mm, robust and stable, high quality steel construction with structured plate, Galvanized version with a galvanized raw framework, Load cells : 4 high quality, OIML approved C 3, DMS load cell, IP 68, type KPZ 502E-3. Weighing Indicator : KPZ 52E91 – sensitive Animal Filter
Certification : EU type approved version, for retail use, CE - conform.



KPZ 2AA, low profile Animal platform scale, dim 560 x 1510 mm, robust and stable, high quality construction of Aluminum with structured plate, Frame height 850mm, with door at the front and back, and wheels for easy transport Load cells : 4 high quality, OIML approved C 3, DMS load cell, IP 67, type KPZ 502E-3. Weighing Indicator : KPZ 52E91, sensible animal Filter. Certification : EU type approved version, for retail use, CE - conform. Capacity : 0 kg, to 300 kg, Division : 100g



KPZ 2A V



WEIGHING SYSTEM FOR SILO

Special models are our speciality!

German design and own EU production guarantees high quality.

We also offer many types of custom design, depending on customer needs.



Special models are our speciality!

German design and own EU production guarantees high quality.

KPZ 2A / Animal scale

Solid Animal scale for hard agricultural use / hot dip galvanized

Capacity : 150/300kg, 600kg and 1500kg, possible



**Standard- Indicator
KPZ 52E-91 IP67**

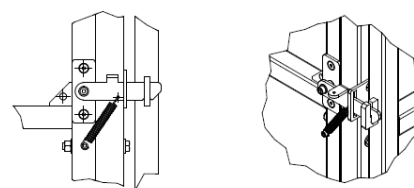

Door lock

**KPZ 2A, 220x92x160cm
1500kg Div. 500g**

Solid and stable animal scale KPZ 2A. **German design and our own EU manufacturing guarantee a high-quality scale.** Platform scale for animals, robust and solid construction, structured plate, metal galvanized protective hurdles. Movable feet with adjustable height, stainless steel. Load cells, IP 68, OIML C3. Certification: EC approval possibility class III, Declaration of Conformity.

Construction: steel, welded frame made of profile with diagonal reinforcement and galvanized solid structured plate, flat construction.

Type	Capacity	Division	Indicator	Approval possible	Dim. mm	Article-No.
KPZ 2 EKO	150/300 kg	50/100 g	KPZ 52-18	No	580x1010x1000	2VAA06100300
KPZ 2 EKO	300 kg	100 g	KPZ 52E91/IP67	Yes	580x1010x1000	2VAA0610030E
KPZ 2 EKO	150/300 kg	50/100 g	KPZ 52-18	No	910x1010x1000	2VAA09100300
KPZ 2 EKO	300 kg	100 g	KPZ 52E91/IP67	Yes	910x1010x1000	2VAA0910030E
KPZ 2 EKO	150/300 kg	50/100 g	KPZ 52-18	No	740x1260x1000	2VAA07120300
KPZ 2 EKO	300 kg	100 g	KPZ 52E91/IP67	Yes	740x1260x1000	2VAA0712030E
KPZ 2 EKO	150/300 kg	50/100 g	KPZ 52-18	No	1160x1260x1000	2VAA10120300
KPZ 2 EKO	300 kg	100 g	KPZ 52E91/IP67	Yes	1160x1260x1000	2VAA1012030E
KPZ 2 EKO	150/300 kg	50/100 g	KPZ 52-18	No	510x1510x1000	2VAA05150300
KPZ 2 EKO	300 kg	100 g	KPZ 52E91/IP67	Yes	510x1510x1000	2VAA0515030E
KPZ 2 EKO	150/300 kg	50/100 g	KPZ 52-18	No	670x1510x1000	2VAA06150300
KPZ 2 EKO	300 kg	100 g	KPZ 52E91/IP67	Yes	670x1510x1000	2VAA0615030E
KPZ 2 EKO	150/300 kg	50/100 g	KPZ 52-18	No	660x1810x1000	2VAA07180300
KPZ 2 EKO	300 kg	100 g	KPZ 52E91/IP67	Yes	660x1810x1000	2VAA0718030E
KPZ 2A	1500 kg	500 g	KPZ 52E91/IP67	No	2200x920x1600	2A0009221500
KPZ 2AE	1500 kg	500 g	KPZ 52E91/IP67	YES	2200x920x1600	2A000922150E
KPZ 2A	1500 kg	500 g	KPZ 52E91/IP67	No	2500x920x1600	2A0009221500
KPZ 2AE	1500 kg	500 g	KPZ 52E91/IP67	YES	2500x920x1600	2A000922150E

Weights & measures | hot dip galvanized | good value for money | solid



KPZ 2AV / Animal scale  
Solid Animal scale for hard agricultural use
Better quality: We use only EU approved components !!!



Standard- Indicator KPZ 52E-91

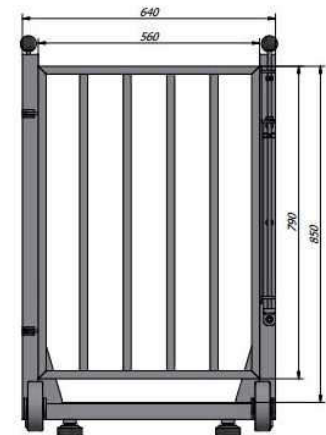
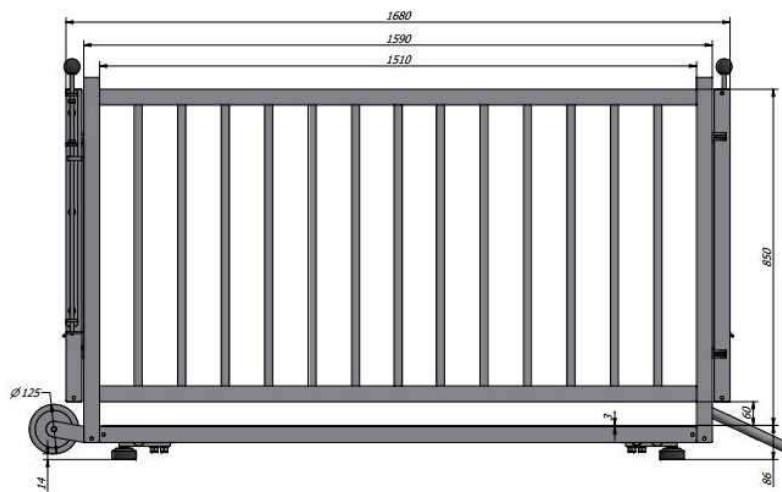
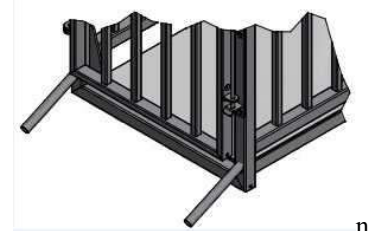

KPZ 2AV, 1510x560x850, 300 kg, division 100g, hot dip galvanized

Typ	Kapazität	Teilung	Abmessungen mm	Eichung möglich	Anzeige	Art.-Nr.
KPZ 2AV	300 kg	100 g	1510x 560x850	No	KPZ 52E91/IP67	2A0005150300
KPZ 2AVE	300 kg	100 g	1510x 560x850	yes 	KPZ 52E91/IP67	2A000515030E

KPZ 2AV animal weighing machine, dim. 560 x 1510 x 850 mm, extremely solid and stable steel construction, structured aluminum platform surface. Construction hot dip galvanized, grid height 850mm with water proof screen plate, with front and rear doors, castors for comfortable transport. Load cell: high-quality, KPZ 502E-3 compliant strain gauge cells, IP 68, OIML C3.

Approvals: EU Class III, CE compliant, legible or non-compliant version available.

Connection: High-quality shielded connection cable m, protected underneath the platform.

Installation: ball base, height-adjustable, floor position, leveling table for leveling platform.

Standard electronic indicator: KPZ 52E91/IP67, with extremely optimized animal filter function

... do not hesitate to contact us !

KPZ 2AA / Animal scale

Solid Animal scale for hard agricultural use
Very light aluminum construction



Solid and stable scales series KPZ 2AA+2AN. German design and own EU production guarantees high quality. Designed as floor scales, for agricultural weighing. High accuracy. Maintenance-free high quality construction of Aluminum or Stainless Steel.

KPZ 2AA+2AN, low profile **ALUMIN**construction Animal platform scale, dim 560 x 1510 mm, robust and stable, high quality construction of Aluminum with structured plate, Frame height 850mm, with door at the front and back, and wheels for easy transport

Load cells : 4 high quality, OIML approved C 3, DMS load cell, IP 67/68, type KPZ 502E-3.

Weighing Indicator : KPZ 52E91/IP67, sensible animal Filter. Certification : EU type approved version, for retail use, CE - conform.

Capacity : 0 kg, to 300 kg, Division : 100g

Aluminium Construction

Typ	Capacity	Div.	Dim. mm	Approval possibility	Indicator	Art.-No.
KPZ 2AA	300 kg	100 g	1470x 470x850	No	KPZ 52E91/IP67	2AA004140300
KPZ 2AAE	300 kg	100 g	1470x 470x850	yes 	KPZ 52E91/IP67	2AA00414030E
KPZ 2AA	300 kg	100 g	1510x 560x850	No	KPZ 52E91/IP67	2AA005150300
KPZ 2AAE	300 kg	100 g	1510x 560x850	yes 	KPZ 52E91/IP67	2AA00515030E

Stainless Steel Construction

Typ	Capacity	Div.	Dim. mm	Approval possibility	Indicator	Art.-No.
KPZ 2AN	300 kg	100 g	1510x 560x850	No	KPZ 52E91/IP67	2AN005150300
KPZ 2ANE	300 kg	100 g	1510x 560x850	yes 	KPZ 52E91/IP67	2AN00515030E

Other dimensions, capacities and options on request.

German design and own EU production guarantees high quality.

Weights & measures | hot dip galvanized | good value for money | solid



KPZ 2ECO / Animal scale

Better quality: We use only EU approved components !!!
The German Construction and own EU production guarantees high quality.



Standard- Indicator
KPZ 52E-91 IP67



KPZ 2A, 220x92cm, 1500kg Div. 500g

Typ	Capazität	Division	Dim. mm	Approval possible	Indicator	Art.-No.
KPZ 2A	1000 kg	500 g	2200x920mm	No	KPZ 52E91/IP67	2AOH09221500
KPZ 2AE	1000 kg	500 g	2200x920mm	YES 	KPZ 52E91/IP67	2AOH0922150E
Options / accessories / extra charge						Article-Nr
Side Bars						

Solid and stable animal scale KPZ 2A series. **German design and our own EU manufacturing guarantee a high-quality scale.** Version as floor scales, for animal weighing. Usable for legal and non-legal applications. High precision. Maintenance-free, Fire galvanized steel construction.

Platform scale for animals KPZ 2A, very robust and solid construction, galvanized structured plate, metal galvanized. Movable feet with adjustable height, stainless steel.

Load cells: High quality load cells DMS type KPZ 502E-3, IP 68, OIML C3. **Indicator:** KPZ 52E-9-1 **Certification:** EC approval possibility class III, Declaration of Conformity.

Construction: steel, welded frame made of profile with diagonal reinforcement and solid structured plate, **galvanized** (option: black powder painted or stainless steel construction). Indicator connection cable: length 5 m, sheltered at way out of scale in case of mechanical damage. Special flat construction is suitable for ground placing. With regard to solid DMS load cells there are no wearing out parts.



Description: solid stainless steel housing IP 67, user-friendly, large function keys. LCD display: 6 digit, various symbols, backlight. Operating temperature from -10°C up to +40°C.
Power supply: 230 V, battery version (option). **Functions:** automatic and manual zero setting, switch Net/Gross weight, 100% tare, multiple tare, unit switching, simple piece counting by reference no. 10, 20, 50, 100 i 200. Minus indication, LCD backlight, automatic shut off after 0-9 minutes, pre-set value control or limit value control LOW – OK - HIGH (any two weight values to choose, tone or light signal), electronic stabilization filter, automatic selftest, error messages.
Indication: zero setting, gross, net, stability, LOW-Bat indication, pre-set/limit value, too small piece quantity or too small weight. **LED:** charging status.

Other dimensions, capacities and options on request.

German design and own EU production guarantees high quality.



KPZ 2S ECO / Platform scale

Solid floor scales up to 800 kg for Standard use

Option : A grid frame with a height of 1000mm can be offered for each KPZ 2 ECO dimension.

Weights & measures | hot dip galvanized Frame | Alumin Top plate | solid



laundry scale
on Request



Solid and stable platform scales KPZ 2ECO. **German design and own EU production guarantees high quality.** Designed as floor scales, industrial weighing. High accuracy. Maintenance-free durable steel construction. Powder paint coated.

Construction: Robust, maintenance-free, welded steel construction, heavy duty design for industrial use, non-slip finish Aluminw eighing platform, durable black powder coat. **Load cells:** Robust, nickel-plated load cell, IP68, OIML, with a high overload capacity. **Levelling feet.** **Installation:** Adjustable leveling feet, designed for permanent or portable installations, 5m cable to connect digital indicator. **Options:** Extra ramps, Base anchors, Wall mounting for indicator, Indicator stand, Custom sizes and capacities

Standard indicator: KPZ 52-18, **For approved applications:** KPZ 52E-8, **Options for indicators:** Multi range, RS 232 serial interface, Various printers connection, Radio data transfer, WLAN, etc.. Internal battery. **Power Supply :** 230 V mains, Power cord. **Approvals:** OIML class III , CE conform.

Type	Capacity	Division	Indicator	Approval possible	Dim. mm	Article-No.
KPZ 2 EKO	150/300 kg	50/100 g	KPZ 52-18	No	580x1010x85	2VA006100300
KPZ 2 EKO	300 kg	100 g	KPZ 52E-8	Yes	580x1010x85	2VA00610030E
KPZ 2 EKO	150/300 kg	50/100 g	KPZ 52-18	No	910x1010x85	2VA009100300
KPZ 2 EKO	300 kg	100 g	KPZ 52E-8	Yes	910x1010x85	2VA00910030E
KPZ 2 EKO	150/300 kg	50/100 g	KPZ 52-18	No	740x1260x85	2VA007120300
KPZ 2 EKO	300 kg	100 g	KPZ 52E-8	Yes	740x1260x85	2VA00712030E
KPZ 2 EKO	150/300 kg	50/100 g	KPZ 52-18	No	1160x1260x85	2VA010120300
KPZ 2 EKO	300 kg	100 g	KPZ 52E-8	Yes	1160x1260x85	2VA01012030E
KPZ 2 EKO	150/300 kg	50/100 g	KPZ 52-18	No	510x1510x85	2VA005150300
KPZ 2 EKO	300 kg	100 g	KPZ 52E-8	Yes	510x1510x85	2VA00515030E
KPZ 2 EKO	150/300 kg	50/100 g	KPZ 52-18	No	670x1510x85	2VA006150300
KPZ 2 EKO	300 kg	100 g	KPZ 52E-8	Yes	670x1510x85	2VA00615030E
KPZ 2 EKO	150/300 kg	50/100 g	KPZ 52-18	No	660x1810x85	2VA007180300
KPZ 2 EKO	300 kg	100 g	KPZ 52E-8	Yes	660x1810x85	2VA00718030E
KPZ 2A	1500 kg	500 g	KPZ 52E91/IP67	No	2200x920mm	2AOH09221500
KPZ 2AE	1500 kg	500 g	KPZ 52E91/IP67	Yes	2200x920mm	2AOH0922150E

... please contact us for special requests!

. German design and own EU production guarantees high quality.

Weights & measures | hot dip galvanized | good value for money | solid

Special models are our speciality!



KPZ 1BSX | Beam scale

Solid Pallet scale for industrial use | Capacity : up to 2.000kg



Inexpensive version

Fixing Clamps for fixed attachment to the beam. Available in a set of 4 or 6 pieces.

e	Capacity	Division	Indicator	Dim. mm	Approval	Art-Nr.
KPZ 1BSXM	1000/2000 kg	500/1000 g	without	85 x 1000	Yes	1BXM00102000
KPZ 1BSXM	1000/2000 kg	500/1000 g	without	85 x 1200	Yes	1BXM00122000
KPZ 1BSXM	1000/2000 kg	500/1000 g	without	85 x 1500	Yes	1BXM00152000
KPZ 1BSXM	1000/2000 kg	500/1000 g	KPZ 52-18	85 x 1000	No	1BSXM0102000
KPZ 1BSXE	1500 kg	500 g	KPZ 52E-8	85 x 1000	Yes	1BSX0010150E
KPZ 1BSX	1500 kg	500 g	KPZ 52-18	85 x 1000	No	1BSX00101500
KPZ 1BSXE	2000 kg	1000 g	KPZ 52E-8	85 x 1000	Yes	1BSX0010200E
KPZ 1BSX	2000 kg	1000 g	KPZ 52-18	85 x 1000	No	1BSX00102000
KPZ 1BSXM	1000/2000 kg	500/1000 g	KPZ 52-18	85 x 1200	No	1BSXM0122000
KPZ 1BSXE	1500 kg	500 g	KPZ 52E-8	85 x 1200	Yes	1BSX0012150E
KPZ 1BSX	1500 kg	500 g	KPZ 52-18	85 x 1200	No	1BSX00121500
KPZ 1BSXE	2000 kg	1000 g	KPZ 52E-8	85 x 1200	Yes	1BSX0012200E
KPZ 1BSX	2000 kg	1000 g	KPZ 52-18	85 x 1200	No	1BSX00122000
KPZ 1BSXM	1000/2000 kg	500/1000 g	KPZ 52-18	85 x 1500	No	1BSXM0152000
KPZ 1BSXE	1500 kg	500 g	KPZ 52E-8	85 x 1500	Yes	1BSX0015150E
KPZ 1BSX	1500 kg	500 g	KPZ 52-18	85 x 1500	No	1BSX00151500
KPZ 1BSXE	2000 kg	1000 g	KPZ 52E-8	85 x 1500	Yes	1BSX0015200E
KPZ 1BSX	2000 kg	1000 g	KPZ 52-18	85 x 1500	No	1BSX00152000
Fixing clamps for KPZ 1B for 85mm profile, 4 pieces						1B0000000100
Fixing clamps for KPZ 1B for 85mm profile, 6 pieces						1B0000000200

Solid and stable scales series KPZ 1BSX. **German design and own EU production guarantees high quality.** **Designed** as floor scales, industrial weighing. High accuracy. Maintenance-free durable steel construction. Powder paint coated.

Construction: Robust, maintenance-free, welded steel construction, heavy duty design for industrial use, durable black powder coat. **Load cells:** Robust, nickel-plated load cell, IP68, OIML, with a high overload capacity.

Levelling feet. Installation: Adjustable leveling feet, designed for permanent or portable installations, 5m cable to connect digital indicator. **Options:** Base anchors, Wall mounting for indicator, Indicator stand, Custom sizes and capacities

Standard indicator: KPZ 52-18, **For approved applications:** KPZ 52E-8, **Options for indicators:** Multi range, RS 232 serial interface, Various printers connection, Radio data transfer, WLAN, etc.. Internal battery.

Approvals: OIML class III , CE conform. **Power Supply** : 230 V mains, Power cord

Special requirements for unique loading / please contact us for more information!



WEIGHING SYSTEM FOR SILO



KPZ 51E-41 indicator

X

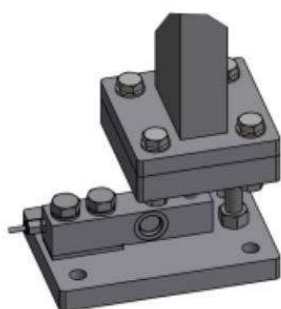

Weighing module – technical data

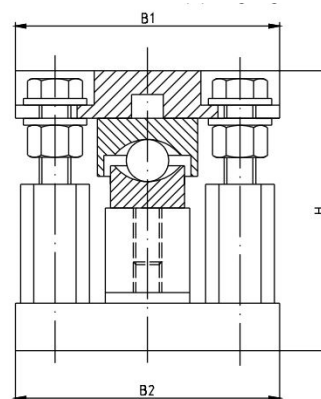
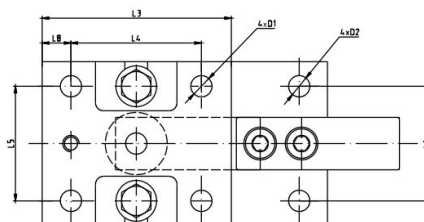
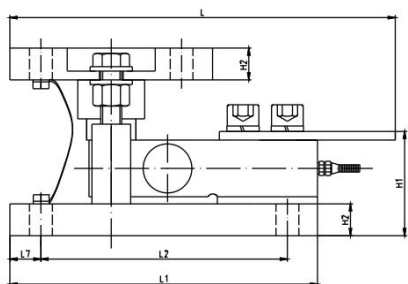

capacity	H	H1	H2	B1	B2	D1	D2	L	L1	L2	L3	L4	L5	L6	L7L	L8
0,1-2,5t	106	58	18	100	100	Ø13	Ø13	210	175	140	1167	80	70	70	17,5	18
3-5t	135	69,1	23	150	150	Ø17	Ø17	270	235	200	150	100	90	90	15	25
7,5-10t	186,3	91,3	38	180	180	Ø26	Ø26	345,2	310	250	210,4	150,4	110	110	30	30

0.1~5t

Weighing module installation

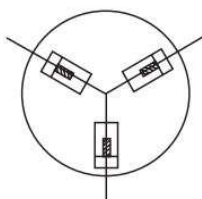

Radial mounting

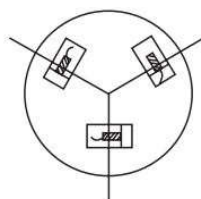

Cutting mounting

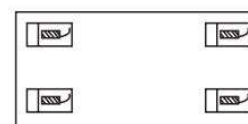

Rectang mounting

German design and own EU production guarantees high quality.

Available load cells capacities: 250kg, 500kg, 1000kg, 1500kg, 2000kg, 2500kg, 3000kg, 5000kg, 7500kg,

Component		Article-Nr.
Indicator KPZ 51E-41		ZM51E4100000
Junction box 4 load cells		ZM0808000000
Junction box 6 load cells		ZM0808000006
Mounting kit up to 2500kg		WM052E302500
Mounting kit up to 5000kg		WM052E305000
Mounting kit up to 10000kg		WM052E310000

10000kg.

KPZ 51E-41 indicator

<p><u>Characteristics:</u> Software: Base</p> <ul style="list-style-type: none"> - Zeroing - Tare - Hand tare - Gross / Net switching - simple piece counting - Add function - automatic zeroing function <p><u>Function (Optional):</u></p> <ul style="list-style-type: none"> - Print function including date and time, external button - I / O inputs as net / gross switching, zeroing, peak value, printout - I / O outputs as set point function - Communication protocol via serial interface - 5 set points (4 set points if analogue output is available) Configurable as open or normally closed. The set points can be set as net weight, gross weight, for positive or for positive and negative weights. - Setting the hysteresis value for each set point. 	<p><u>Option (extra charge):</u></p> <ul style="list-style-type: none"> - Wall mounting - Stand - Battery - Alibi memory - Analog output - I/O's, relay output - Printer - Serial interface RS232 and RS485 - Remote display - Profibus, Ethernet TCP/IP, Modbus, CANopen, DeviceNet. <p><u>Power supply:</u></p> <ul style="list-style-type: none"> - Mains 110-240VAC, 3m long cable <p><u>Technical Data:</u></p> <ul style="list-style-type: none"> - LCD display, backlit (6 digit 20mm high, semi alphanumeric) - 16 icon displays - Robust ABS housing IP67 - Temperature range: -10 ° C to 40 ° C - dim. 122x226x164mm - EU type approval Class III to 10,000e
---	--

KPZ 502E-3, Scherstab-Wägezelle, legierter Stahl, IP68, C3
Shear beam load cell, alloy steel, IP68, C3
Tenzometrický snímač hmotnosti alloy steel, IP68, C3
Kapazität/Capacity/ Váživost : 250kg - 5000kg

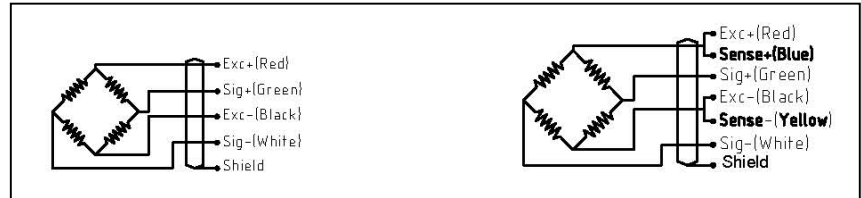
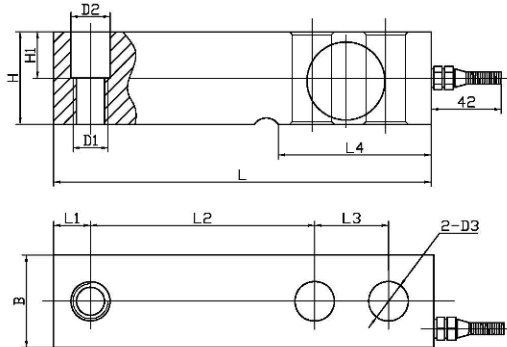

Abmessungen / dimensions:

Kapazität / capacity		L	H	B	L1	L2	L3	L4	D3	H1	D2	D1
250 – 2.500kg	mm	130,0	31,8	31,8	12,7	76,2	25,4	53,5	13,0	20,0	13,5	M 12 x 1,50
3.000 - 5000kg	mm	171,5	38,1	38,1	19,0	95,3	38,1	72,5	20,0	26	20,0	M 18 x 1,50

Technische Daten / specification:

Emax	t	0,25	0,5	1	1,5	2	2,5	3	5
Vmin	kg	0.02	0.05	0.1	0.15	0.2	0.25	0.3	0.5
Emin	kg	0							
Dmin	kg	0							
Humidity Class		CH							
Accuracy class		C3							
Zero balance	%F.S	±1							
Rated output	mV/V	3.0±0.0.003							
Y parameter		10000							
Z parameter		3000							
Resistance Input	Ω	400±10							
Output	Ω	352±3							
Insulation	MΩ	≥5000							
Safe load limit	%F.S	150							
Lateral load limit	%F.S	180							
Recommend excitaion	V.DC	10							
Maximum excitaion	V.DC	15							
Protection class		IP68							
Construction		Alloy steel							
Operating Temp Range	°C	-10~40							
Cable length	m	As per customers' requirements							

KPZ 502E-3, Scherstab-Wägezelle, legierter Stahl, IP68, C3
Shear beam load cell, alloy steel, IP68, C3
Tenzometrický snímač hmotnosti alloy steel, IP68, C3
Kapazität/Capacity/ Váživost : 7,5t – 10t

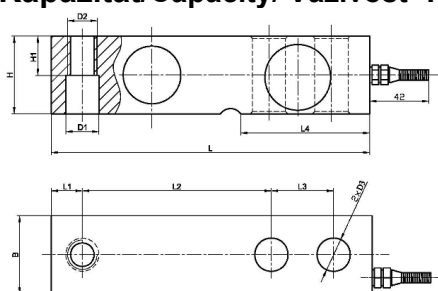



Abmessungen / dimensions:

Kapazität / capacity		L	H	B	L1	L2	L3	L4	D3	H1	D1	D2
7,5t – 10t	mm	225,5	50,8	50,8	25,3	124,0	50,8	102	27,0	25,4	27,0	M 24 x 2,0

Technische Daten / specification:

Emax	t	7.5	10
Vmin	kg	0.75	1.0
Emin	kg		0
Dmin	kg		100
Humidity Classification			CH
Accuracy class			C3
Zero balance	%F.S		±1
Rated output	mV/V		3.0±0.03
Y parameter			10000
Z parameter			3000
Resistance Input	Ω		400±20
Output	Ω		352±3
Insulation	MΩ		≥5000
Safe load limit	%F.S		150
Lateral load limit	%F.S		200
Recommend excitaion	V.DC		10
Maximum excitaion	V.DC		15
Protection class			IP68
Construction			Alloy Steel
Operating Temp Range	°C		-10~40
Cable length	m	As per customers' requirements	

KPZ 599-5, Bearing Foot for KPZ 502E-3 Shear Beam
 KPZ 599-5 Stabiler Fuß zur KPZ 502E-3 Scherstab-Wägezelle
 Stabilní nožička k KPZ 502E-3 shearbeam-snímač
 Selfleveling, chrome plated with adjustable thread M12 or M18
 Selbst nevlíerend mit Kugel, verchromt, mit Gewinde M 12 oder M18
 Samonastavovací s kuličkovým ložiskem, chromovaná se závitem M 12 nebo M 18

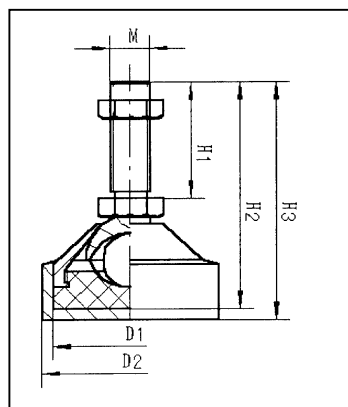
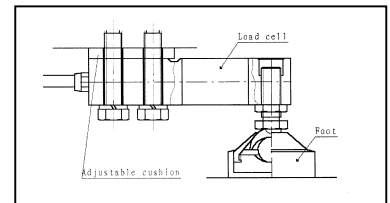



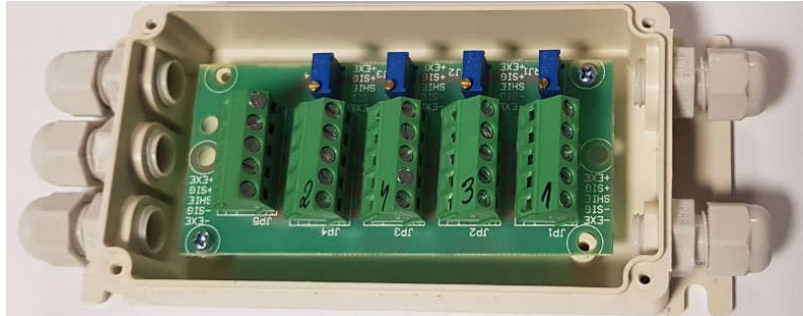















Technical data							
Capacity	Art. number	D1	D2	H1	H2	H3	M
250 – 2.500kg	01052E302500	Ø54 mm	Ø62 mm	45 mm	85 mm	85 mm	M 12 x 1,75 mm
3.000 - 5000kg	01052E305000	Ø54 mm	Ø62 mm	60 mm	105 mm	110 mm	M 18 x 1,50 mm



Z0909000000
 Slučovací skříňka KPZ Z09-9, pro 4 tenzometry v robustním ABS pouzdře , s potentiometrem
 KPZ Z09-9, junction box, board with potentiometer, for up to 4 load cells, in ABS housing, with cable glands:
 Sammeldose KPZ 09-9, für 4 Wägezellen, im robustem Plasticgehäuse, mit Potentiometer.

KPZ 502E-3 Scherstab Wägezelle, Werkzeugstahl vernickelt, IP 68, Kap. 1000kg, Gewinde M12/M18, eichfähig C3
 KPZ 502E-3 share beam load cell, nickel plated steel, IP 68, Cap. 1000kg, approved C3, M12/M18 thread
 KPZ 502E-3 tenzometrický snímač, nástrojová ocel, pozinkovaný, IP 68, s polovičním dírovým závitem M 12/M18, cejchuschopný C 3,

Typ	Capacity/kg		Approval	Article No.
KPZ 502E3	250	alloy steel	YES/Ano/JA 	W052E3000250
KPZ 502E3	500	alloy steel	YES/Ano/JA 	W052E3000500
KPZ 502E3	1.000	alloy steel	YES/Ano/JA 	W052E3001000
KPZ 502E3	1.500	alloy steel	YES/Ano/JA 	W052E3001500
KPZ 502E3	2.000	alloy steel	YES/Ano/JA 	W052E3002000
KPZ 502E3	2.500	alloy steel	YES/Ano/JA 	W052E3002500
KPZ 502E3	3.000	alloy steel	YES/Ano/JA 	W052E3003000
KPZ 502E3	5.000	alloy steel	YES/Ano/JA 	W052E3005000
KPZ 502E3	7.500	alloy steel	YES/Ano/JA 	W052E3007500
KPZ 502E3	10.000	alloy steel	YES/Ano/JA 	W052E3010000
KPZ 502E3N	250	Stainless	YES/Ano/JA 	WN052E300250
KPZ 502E3N	500	Stainless	YES/Ano/JA 	WN052E300500
KPZ 502E3N	1.000	Stainless	YES/Ano/JA 	WN052E301000
KPZ 502E3N	1.500	Stainless	YES/Ano/JA 	WN052E301500
KPZ 502E3N	2.000	Stainless	YES/Ano/JA 	WN052E002000
KPZ 502E3N	2.500	Stainless	YES/Ano/JA 	WN052E002000
KPZ 502E3N	3.000	Stainless	YES/Ano/JA 	WN052E003000
KPZ 502E3N	5.000	Stainless	YES/Ano/JA 	WN052E005000
Feet	Fuß			
KPZ 599-5	250 – 2.500	Feet		010530023000
KPZ 599-5	3.000 - 5000	Feet		010530024000
KPZ 599-5	7.500 - 10000	Feet		010530025000
Junctionbox	Sammeldose			
KPZ Z09-9,				Z09090000000

Indicator Type	Article-Nr
Indicator KPZ 52E-8	Z52E8000000
Indicator KPZ 52E-8/1, with pre tare and easy counting	Z52E81000000
Indicator KPZ 56E-3, professional counting, addition, Tare input by hand	Z56E30000000
Indicator KPZ 56E-4, professional counting, addition, Tare input by hand, (frontpanel version)	Z56E40000000
Indicator KPZ 52-18	Z52180000000
Indicator KPZ 52-19 (forntpanel version)	Z52190000000
Indicator KPZ 52-7-2 (frontpanel version)	Z52720000000
Indicator KPZ 52E-9-1, Stainles steel housing (IP 67) easy counting	Z52E91000000
Indicator KPZ 51E-9-2, Stainles steel housing (IP 67), High/OK/LOW, 10 Memory	Z51E92000000

KPZ Indicators

 <p>KPZ 52E-7</p> <p>Klasse III M</p>	 <p>KPZ 52E-7/1</p> <p>Klasse III M</p>	 <p>KPZ 56E-4</p> <p>Klasse III M</p>
 <p>KPZ 52E-9-1</p> <p>Klasse III M</p>	 <p>KPZ 51E-9-2</p> <p>Klasse III M</p>	 <p>KPZ 51E11 - 13</p>
 <p>KPZ 58-2</p> <p>Klasse III M</p>	 <p>KPZ 52-19</p>	 <p>Big display/second display</p>
 <p>KPZ 54E-*</p> <p>Klasse III M</p>	 <p>KPZ 54E-*</p> <p>Klasse III M</p>	

KPZ Indikátory



Klasse

Multirange division : See technical data of the scale. OIML Class

Description KPZ 52(E) - 7

Robust external case made from ABS incorporating a water-proof front keypad with large function keys. 6- digit, 26 mm high LCD – Display with back-light function providing a clear and easily readable weight indication. Operating temperature – 10 to + 40 °C. 230 Volt-operation.

Function : automatic and manual Zero setting. Tare setting up to 100 %, switch Net and gross weight repeatedly. Optional RS 232 Data output and addition sum printing, minus indication, LCD back-light (3 settings), audible/visible alarm/check HIGH-OK-LOW (That means two available value of weight), automatic selftest, Error message on display.

LED indication for : Zero, Tare weight, stabile, LOW Bat, power, addition memory.







Options: Configurable RS 232 output, data output (different formats), Roller printer, label printer, set point (High-OK-Low),

Key	Description
ON/OFF	This key is installed on the ABS housing. This key is used to switch the indicator ON or OFF. When activated the display shows the $\rightarrow 0 \leftarrow$ signal is on.
$\rightarrow 0 \leftarrow$	If the LCD Display is not indicating 0.00 , press this key to re-zero the scale. The display indicates that the ZERO signal is now on. The unit can zero $\pm 2\%$ of the max. capacity. Using this switch do not change the range of maximal capacity.
$\leftrightarrow T$	This key is used to carry out tare and zero settings, when an existing weight is on the scale. If a TARE weight is stored, the Tare Signal will indicate over Net . As soon as you remove the TARE weight re-set to ZERO by the user of the scale, the display shows the weight with a minus symbol in front on the LCD display. The maximum weighing range is reduced for the tare value. Tare capability is 100% of the scale capacity, and can be used repeatedly. Multiple tare is possible. Negative weight values can be moved to 0.00 .
NET GROSS	This key is used to switch between net and gross weight repeatedly. The display indicate Net or τ GROSS. This $\frac{NET}{GROSS}$ key can be used only when the scale is in the tare mode. By showing the Gross value (τ GROSS) the other keys are closed.
	If a printer interface is installed, this key will print out (printer version) or transfer the weight data being displayed . The weight value is stored in the data logger. The display indicate τ M+ .To print the grand total of all printed weights the weight must be removed. The display shows $\rightarrow 0 \leftarrow$. Then press the key twice the total sum of the weighing results will be printed .

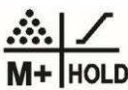
KPZ Indicators



Robust external case including a water-proof front keypad with large function keys. 6-digit, 30 mm high LCD – Display with blue back-light function providing a clear and easily readable weight indication. Operating temperature – 10 to + 40 °C. 230 Volt-operation. Battery operation possible. **Function** : automatic and manual Zero setting. Tare setting up to 100 %, pretare function, switch Net and gross weight repeatedly. Optional RS 232 Data output and addition sum printing, minus indication, HIGH-OK-LOW function, totalizing function, automatic selftest, Error message on display. **LED indication for** : Zero, Tare weight, stable, LOW Bat, HI LOW OK .
Options: RS 232 output, data output, Roller printer,

Key	Function	Hold for 1 sec.
	Printout / data output (Option)	Communication settings
Σ	Totalizing	
	Modus selection / Function	/
	Switching between net and gross weight (net mode)	
UNIT	switching units	/
	Switch between weight / unit weight (piece counting mode)	
	Tare	<ol style="list-style-type: none"> 1. Backlight 2. Switch on zero setting 3. Gravitation value
	Pretare	
	Zero	battery voltage

KPZ Indicators

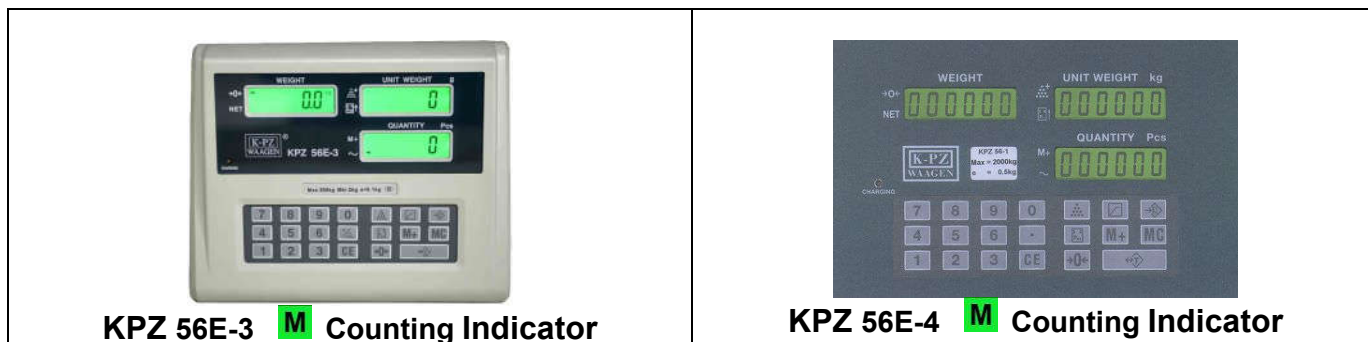

Optimal unit weight for the piece count: 1/5 of the scale division.

This high-quality Parts Counting Indicator can be used in all types of uncertified and for trade weighing applications. Due to the high external resolution and the 20x expanded internal resolution, the unit is ideally suitable for both small and large item component counting. The expanded internal resolution of the indicator provides clear signal stability and repeatability. The 3 window highly visible LCD-Display provides the operator with clear data information. Additionally, with the robust construction of a steel housing, built-in rechargeable battery, and the simple to operate dust and waterproof front keypad, makes this part counting indicator a valuable tool for all industrial weighing & counting applications.

Description of Keypad

0 to 9 and .	Use to enter piece weight, total quantity or Tare value.
CE:	Deletes all value entered via the keypad.
→0←	1) Use this key to Zero the scale 2) Use this key by pressing twice to enter backlight options (see Backlight Function)
	Use this key to Tare the scale
	Use this key to confirm entered quantity.
	Use this key to confirm entered piece weight.
	Use this key to pre-set upper count limit, when the value is achieved an audible signal will be emitted.
	Use this key to save a piece weight in memory.
M+	Count accumulation key.
MC	Deletes all accumulation count in memory.

Standard features :Indicator: Display indication 1/30.000, internal divisions 1/600.000. Built-in calibration routine. Automatic & manual zero setting. 100% Tare. Piece Counting. The tare value and the piece weight can be weighed or entered via the front keyboard. The indicator has a 10 piece weight memory. 3 window LCD display with back-lighting option showing weight, quantity and individual piece weight. Counting accumulation. Audible peak alarm for Multi counting applications. Symbol indication shown at display for : Power re-charging control, LO-BAT. Zero, Tare, Stable, Memory, Piece number, Piece weight.

Options :

Factory configured serial interface (RS 232). With this interface in addition to date, weight & count information, two additional 15 character line entries can be included (for example Item number, operator number etc.) Printing from this interface via a single tally roll printer or label printer which will print all data in a numerical format, or in a range of standard **Barcodes**.

KPZ Indicators

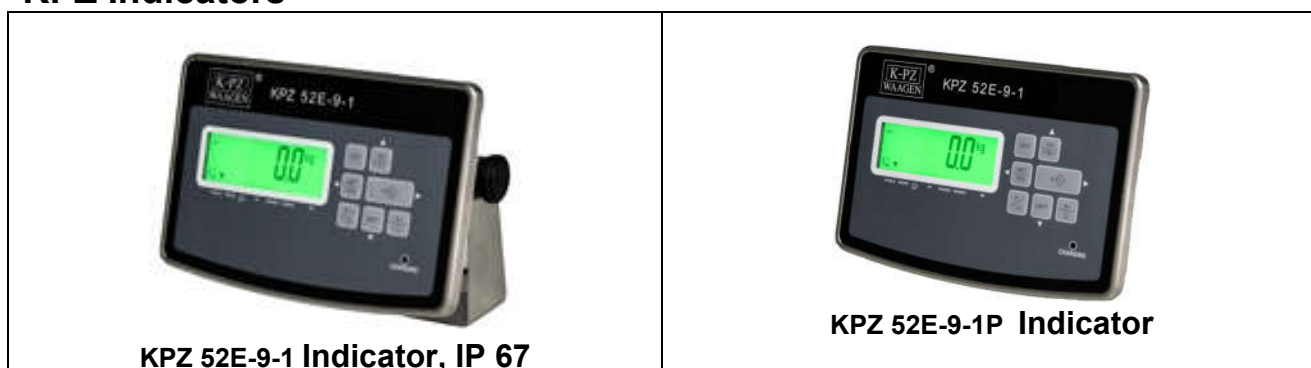

KPZ 52E-9-1 Indicator, IP 67

KPZ 52E-9-1P Indicator

OIML trade approved Class III , 10.000 e

Technical data: Indicator: **KPZ 52E-9-1** robust, stainless steel housing **IP 67**, user-friendly, large function keys. LCD display: 6 digit, various symbols, backlight, high of digits 25 mm. Operating temperature from -10°C up to $+40^{\circ}\text{C}$, operation 230 Volt through external power supply, inbuilt battery (possibility of battery operation).

Functions: automatic and manual zero setting, switch Net/Gross weight, 100% tare, multiple tare, unit switching, simple piece counting by reference no. 10, 20, 50, 100 i 200. Possibility to enter data and bring out data through serial interface (optional): computer functional control, possibility of choosing different exit formats, **printout in simple format**, edition activation: via computer, continuously or after zero come back. Minus indication, LCD backlight, automatic shut off after 0-9 minutes, pre-set value control or limit value control LOW – OK - HIGH (any two weight values to choose, tone or light signal), electronic stabilization filter and signal distortion, automatic self test, error messages.

Indication: zero setting, gross, net, stability, LOW-Bat indication, pre-set/limit value, too small piece quantity or too small weight. **LED:** charging status. **Options:** serial interface RS 232, battery, label printer

Key functions:

Key	Description
ON	<i>switch the indicator ON</i>
→0←	<i>Switch the indicating to 0.00</i>
OFF	<i>switch the indicator OFF</i>
↔T	<i>TARE function</i>
NET GROSS	<i>Switch over Net / Gross Tare, repeatedly</i>
UNITS	<i>Switch over weighing units</i>
F/HR	<i>In approval version: High resolution indication (5 sec)</i>
M+	<i>Totalizing and printout/ data output</i>

Robust external case including a water-proof front keypad with large function keys. 6- digit, 30 mm high LCD – Display with blue back-light function providing a clear and easily readable weight indication. Operating



IP 67,

10 Setpoint memory
Tare setting by key,
Zero setting,
Alarm / check control setting,
back light LCD-Indicator,
Addition sum memory,
Multi range division,

OIML Class  **M** 10.000 e

Keypad :



Rear view and Dimension:

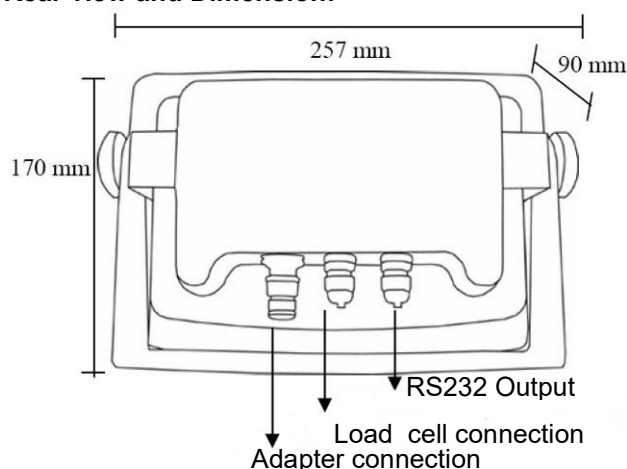

(For IP 67 use only cable diameter from 3 to 5,5mm)

Short description KPZ 51 E – 9 – 2 :

Case:

Compact, robust, high-quality stainless steel case **IP 67.** with hanger to the wall mounting or table mounting (optional stand possible), cable connecting by cable glands.

Indication and keyboard:

6-digit 25 mm high LCD – Display with back-light function providing a clear and easily readable weight indication, and a great, illuminated, coloured joist graphic display, membrane keypad with 16 buttons.

Symbol indication for : zero, tare, stable, LOW Bat, accumulator tension joist , check weighing HIGH-OK-LOW.

Basic functions:

automatic and manual Zero setting. Tare setting op to 100 %, Pretare, switch Net, tare and gross weight repeatedly. Target weight check tolerance with+(/), limit value control (limit = range of Low/Ok/High), 10 debit-/ limit value lofts. About parameter attitude: Percentage function, automatic switching off of backlight and electronics, interface functions and parameter.

Feature :

Multi range, selectable weighing unit, automatic zero correction, automatic shutoff 0-9 minutes, automatic. Backlight, digital stabilization and disturbance filters, measuring speed, gravitation zones, self-test function and error messages.

Energy:

internal accumulator, power supply unit of 230 VAC.

Certifications:

EU-calibrating admittance class  to 10,000 e.

Technical date:

Max . recommended external resolution 30,000 div, min . sensitiveness 0.3 µ V/d, supply voltage 5 VDC, zero input signal-1 to 5 mV, weight input signal-1 to 14 mV up to four 350 Ω load cells, linearity 0.01% F.S.,operating temperature-10 to +40° C. **ptions:** Configurable RS 232 output, data output (different formats), Roller printer, label printer, set point (High-OK-Low),

Extended functions and optional possibilities (surcharge):

Connection:

Serial interface RS232 bidirectional, data output format and mode choice, factory programmable format, date and time, relay exit for alarm/check points.

KPZ 54-* / Touch screen indicator



- Touch Operating System for user friendly and fastest operations.
- Multi-printer selectable
- Custom printout options,
- Multi -language support
- Report management.
- PC keyboard and Mouse can be connected
- Software upgrade option.
- 9999 products possible to store in memory.
- designed for multiple use, such as Weighing, Target, Counting, Check weighing and Recipe operations.
- 2xUSB port, 1xRS232, optional more ports possible
- 7' or 8' display possible
- Robust ABS or stainless steel housing possible
- Dual scale option (extra charge) possibility



KPZ 51E-45K

IP69K

AISI 304 stainless steel weight Indicator (dimensions: 206x286x108 mm) with 6 PG9 cable glands, **IP69K protection rating**, stainless steel adjustable bracket included (overall dimensions with bracket: 206x290x187 mm). Optionals: panel / desk / column mounting. Six-key membrane keyboard with buzzer. Real-time clock with buffer battery.

Weight reading by another instrument via serial port.

Two serial ports (RS232 and RS485) for connection to:

- PC/PLC up to 32 instruments (max 99 with line repeaters) by ASCII protocol or ModBus RTU.
- Remote display.
- Printer.
- Optional integrated output: Profibus DP, DeviceNet, CANopen, Profinet IO, Ethernet/IP, Ethernet TCP/IP, Modbus/TCP.

Main functions:

- 5 setpoints (4 setpoints if Analog Output is present) configurable as normally open or normally closed. The operator can decide the setpoints activation for the net weight value, gross weight value, otherwise for positive weights or for positive and negative weights.
- Counting.
- Totalizing.
- Setting of hysteresis value for each setpoint.
- 12 groups selection by 5 setpoint from selector switch or contacts (EC/E options).
- Peak holder displaying by closing the Peak contact.
- Net/Gross function by keyboard or external contact.
- Manual adjustment of zero value in case of zero-setting not possible.
- Auto zero function.
- Auto zero-tracking function.
- Print of the weight via keyboard or external contact with date and time.

Operation: The inputs can work as: net/gross weight, zero-setting, peak, print or can be remotely read via protocol.

The outputs can work as setpoints or can be remotely switched via protocol.

Weight transmitter approved OIML R61 (Automatic Gravimetric Filling Instruments) according to WELMEC Guide 8.8:2011 (MID).

approvable EN45501-2014/31/UE-OIML R76:2006

- Maximum number of verification scale intervals n=10000
- Minimum input-voltage per VSI 0.2 µV
- Weighing range single range or multi range (max 3) or multi interval (max 3)
- Calibration via keyboard is protected through seals for the access to a setting jumper or installer password
- Semi-automatic zero and tare, predetermined tare functions.
- Weight subdivisions displaying (1/10 e)
- The following values can be printed from external contact: net/gross weight; tare; predetermined tare; date; time; ID code (if alibi memory is present)



KPZ 51E-41 indicator

Characteristics:

Software: Base

- Zeroing
- Tare
- Hand tare
- Gross / Net switching
- simple piece counting
- Add function
- automatic zeroing function

Function (Optional):

- Print function including date and time, external button
- I / O inputs as net / gross switching, zeroing, peak value, printout
- I / O outputs as set point function
- Communication protocol via serial interface
- 5 set points (4 set points if analogue output is available) Configurable as open or normally closed. The set points can be set as net weight, gross weight, for positive or for positive and negative weights.
- Setting the hysteresis value for each set point.

Option (extra charge):

- Wall mounting
- Stand
- Battery
- Alibi memory
- Analog output
- I/O's, relay output
- Printer
- Serial interface RS232 and RS485
- Remote display
- Profibus, Ethernet TCP/IP, Modbus, CANopen, DeviceNet.

Power supply:

- Mains 110-240VAC, 3m long cable

Technical Data:

- LCD display, backlit (6 digit 20mm high, semi alphanumeric)
- 16 icon displays
- Robust ABS housing IP67
- Temperature range: -10 ° C to 40 ° C
- dim. 122x226x164mm
- EU type approval Class III to 10,000e

Big display (second display), can be combined with all KPZ Indicator

Model : KPZ GD 1-1

150057052000 Large display KPZ GD1-1, 6-digit, 127 mm LED dot matrix, with 5m connection cable and interface for connection to the display KPZ 52 (E) - *

Model : KPZ GD 2

150057062000 Großanzeige KPZ GD2-1 6-stellig, 76 mm LED's dot Matrix, mit 5m Anschlußkabel und Interface zum Anschluß an die Anzeige KPZ 52 (E)-*



PC Software K-PZ Smart Scale

Software K-PZ Smart Scale is a modern software specially designed to manage weighing data. A custom function selection is possible depending on different stages of development. Moreover, it is possible to customize software according to customer requirements.

It provides an extremely user-friendly interface and easy of operation.

Software used to manage weighing data, transmitted via the interface of the scale.

It saves time and transmission errors that may occur by manual data input.

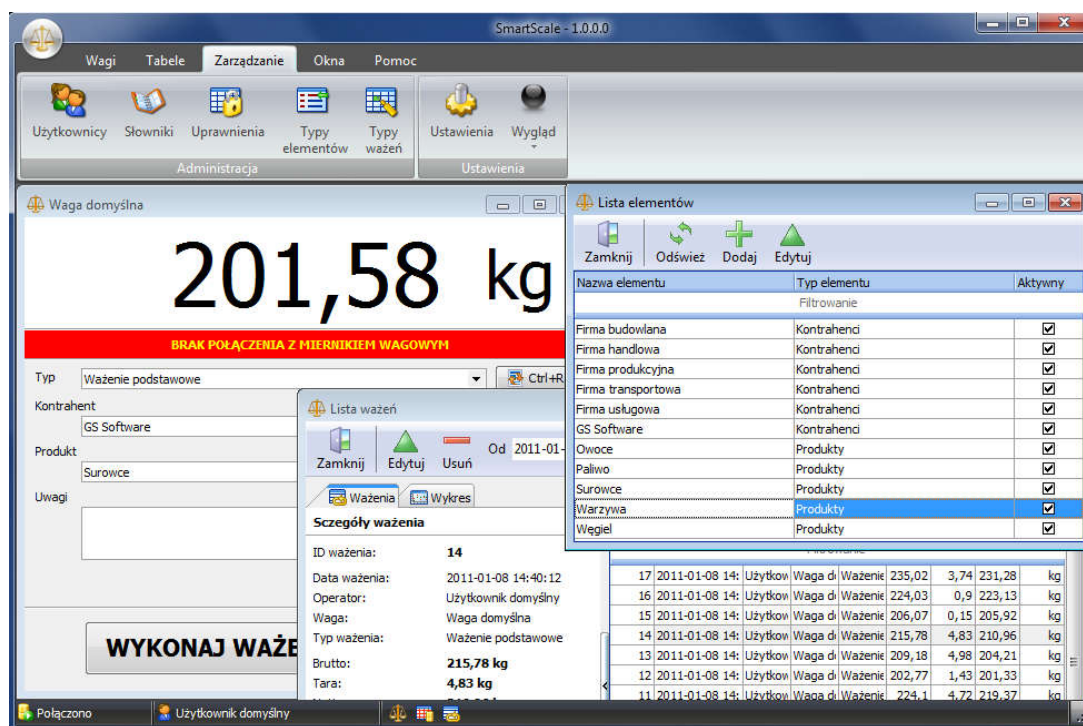

View of the main window

Depending on the configuration following option possible :

- Adjustment of customer-specific data
- Admin data managing
- User managing
- Export to TXT, CSV, RTF, JPG, XLS file
- Print out
- Label printing

Software comes with a USB flash drive activation key.

system Requirements:

Minimum requirements:

- hardware – Processor Intel Pentium 4, 512 MB RAM, 100 MB of the hard drive free;
- software: Windows 2000 (SP4), XP (SP2), Vista, Win7

Depending on version of KPZ Smart Scale , the following functionality is possible:

Function	Programm version		
	Standard	Professional	Premium
Facility to connect only one scale indicator	X		
Facility to connect any number of indicators the same time		X	X
Handling any model of KPZ indicator	X	X	X
Access to weighing list data window	X	X	X
Export weighing list data to the .TXT or .CSV file	X	X	X
Export weighing list data to the .XLS file (installation of MS Excel not necessary)		X	X
Weighing list data overview on the chart	X	X	X
Save the chart (weighing list data) as a picture	X	X	X
Weighing search	X	X	X
Weighing ticket preview	X	X	X
Save weighing ticket as PDF file	X	X	X
Edit data assigned to the weighing	X	X	X
History of weighing changes preview			X
Access to the Report Generator		X	X
Generating report to any data		X	X
Save the report as .PDF file		X	X
Export report data to .RTF, .CSV, .JPEG, XLS file (installation of MS Excel is necessary)		X	X
Export report data to . XLS file (installation of MS Excel not necessary)			X
Using programm as default user (with out Log in-Panel)	X		
Using programm as defined User or Admin		X	X
User Authorization Management			X
Facility to perform weighing without additional data	X	X	X
Facility to perform weighing with additional data: contractor, product, comments,	X	X	X
Facility to perform weighing with additional data: contractor, product, comments, + 2 additional dictionaries, + 2 additional text fields		X	X
Facility to perform weighting with any data type. Possibility to build any data structure.			X
Access to the window allowing to create dictionaries in a database			X
Network version		X	X
Print out as graphic or text mode	X	X	X
Facility to print out the logo on the ticket weighting (graphic mode)	X	X	X
Facility to create license data (one set only)	X		
Facility to create any number of license data set		X	X
Virtual Scales mechanism (planned)		X	X
Label ticket operation (planned)		X	X
Multi-language	X	X	X

Printers for KPZ scales

More printers and options on request!

Thermal printer Favorit 24	
Dimensions	85 x 85,5 mm (B x H)
Own weight	150 g
Power supply	Scale's battery
Interface	serial RS232
Version	Thermo-Direkt-Drucker, 203 dpi,
Paper	Paper width: 57 mm



Ticket printer DR 2	
Dimensions	93x173x190 mm (B x H x T)
Own weight	1,2 kg
Power supply	230 VAC / 20 V DC 2,5 A
Interface	serial RS232, Parallel
Version	Thermo-Direkt-Drucker, 203 dpi,
Paper	Etiquette width : max 61mm



Ticket printer DR 6	
Dimensions	ca. 109 x 171 x 209 mm (B x H x T)
Own weight	ca. 1,2 kg
Power supply	100-240 VAC / 24 VDC 2,1 A
Interface	seriell RS232, Parallel
Version	Thermo-Direkt-Drucker, 203 dpi,
Paper	Etiquette width: 15-60mm



Thermal printer Favorit	
Dimensions	85 x 85,5 mm (B x H)
Own weight	150 g
Power supply	Scale's battery
Interface	serial RS232
Version	Thermo-Direkt-Drucker, 203 dpi,
Paper	Paper width: 57 mm



Rollerprinter DR 7	NEW
Dimensions	110 x 125 x 70 mm (B x H x T)
Own weight	600 g
Power supply	230 VAC / 9 V DC 3,2 A
Interface	RS232, USB
Version	Thermo-Direkt
Paper	Papierbreite: 58mm, 20m, Ø40mm



Rollerprinter DR 7	
Dimensions	160 x 139 x 248 mm (B x H x T)
Own weight	2,3 kg
Power supply	230 VAC / 20 V DC 2,5 A
Interface	serial RS232, Parallel
Version	9- Needle printer, alphanumerischer Ausdruck
Paper	Paper width: 76 , 69,5 or 57,5 mm max. 40 digits on column



K-PZ Waagen
 Kanalsteck 9
 21129 Hamburg
 Tel. 040 / 742174-0
 Fax 040 / 742174-99
 TICKET NO. 1
 Art.-Nr.: 123456
 PCS 40
 APW 100 g
 G 5.001 kg
 T 1.000 kg
 N 4.001 kg



KPZ 719SJDR
Exemplary formats
Indikátor KPZ 52 19



TICKET NO.0001
GS 124.5 kg
TR 20.0 kg
NT 104.5 kg

TICKET NO.0002
GS 124.0 kg
TR 20.0 kg
NT 104.0 kg

TOTAL NUMBER
OF TICKETS 0002
TOTAL WEIGHT
248.5 kg

Indicator KPZ 5218



23/08/2016, 16:42:45

TICKET NO.0001
G 2.0kg
T 0.0kg
N 2.0kg

23/08/2016, 16:43:01

TICKET NO.0002
G 5.6kg
T 0.0kg
N 5.6kg

23/08/2016, 16:43:13

TOTAL NUMBER
OF TICKETS 0002
TOTAL
NET 7.6kg

KPZ printers

Exemplary formats / Indicator KPZ 52(E) – 7 / Indicator KPZ 52(E) - 8

Examples are standard formats to printers KPZ. Possibility computer formats. Possibility of formats on customer request!

Exemplary print out Simple format 3	
S/N	WT/kg
0001	100,0
0002	200,0
0003	300,0
0003	600,0

Exemplary print out Complete format 4	
TICKET NO.0001	
G	100,0g
T	0,0g
N	100,0g
TICKET NO.0002	
G	200,0g
T	0,0g
N	200,0g
TICKET NO.0003	
G	300,0g
T	0,0g
N	300,0g
TOTAL NUMBER OF TICKETS 0003	
TOTAL	
NET	600,0g

G = Gross
T = Tare
N = Netto

Exemplary print out Stable format 5	
S/N	WT/kg
0001	100,0
0002	200,0
0003	300,0
0003	600,0

KPZ printers

Exemplary formats / Indicator KPZ 56-3/ KPZ 56-4 / KPZ 2-04-7 scale

Examples are the standard formats. Other formats are possible on request.

Example - format 1:

20.000	kg
7.975	kg
12.125	kg
13.380	kg

Example - format 2:

Ticket NO.	1	
Q'TY	40	PCS
APW	100	g
G/B	5.000	kg
T	1.000	kg
N	4.000	kg

Ticket NO.	2	
Q'TY	290	PCS
APW	100	g
G/B	30.000	kg
T	1.000	kg
N	29.000	kg

TOTAL TICKETS:	2
TOTAL Q'TY:	330 PCS

Example - format 3:

Date:	03-03-00	
Time:	09:04:43	
ID#:	123456789012345	
Part#:	543210987654321	
Ticket NO.	1	
Q'TY	40	PCS
APW	100	g
G/B	5.000	kg
T	1.000	kg
N	4.000	kg

Date:	03-03-00	
Time:	09:04:43	
ID#:	123456789012345	
Part#:	543210987654321	
Ticket NO.	2	
Q'TY	290	PCS
APW	100	g
G/B	30.000	kg
T	1.000	kg
N	29.000	kg

TOTAL TICKETS:	2
TOTAL Q'TY:	330 PCS

Example - format 4:

S/N	WT/kg	PCS
1.	20.000	3333
2.	20.000	3333
3.	8.000	1333
3/	TOTAL	Q'TY:
	7999	PCS

Example - format 5:

Date:	03-03-00	
Time:	09:04:43	
ID#:	123456789012345	
Part#:	543210987654321	
S/N	WT/kg	PCS
1.	20.000	3333
2.	20.000	3333
3.	8.000	1333
3/	TOTAL	Q'TY:
	7999	PCS

Printing formats

Indicator KPZ 56E-3 / KPZ 56E-4

Scale KPZ 2-04E-7

inkl. PT and Addition

Indicator KPZ 51E-9-2

standard format

NO.	1
G	276.7 kg
T	104.5 kg
PT	22.2 kg
N	150.0 kg
U/W	12 kg
PCS	13 pcs

NO.	2
G	176.7 kg
T	104.5 kg
PT	22.2 kg
N	50.0 kg
U/W	12 kg
PCS	4 pcs

=====	
T/N	2
T/W	200.0 kg
T/A	17 pcs

PT = Pretare

U/W = Unit Weight
PCS = Quantity

T/N = Total weighings
T/W= Total Netto weight
T/A= Total quantity

Example - format 1:

DATE:	03/03/2000
TIME:	09:04:43
TICKET NO.	01
NET:	+ 4.500 kg
GROSS:	+ 6.000 kg
TARE:	+ 1.000 kg
PRETARE:	+ 0.500 kg

DATE:	03/03/2000
TIME:	09:04:55
TICKET NO.	02
NET:	+ 5.500 kg
GROSS:	+ 6.000 kg
TARE:	+ 0.000 kg
PRETARE:	+ 0.500 kg

DATE:	03/03/2000
TIME:	09:05:35
TOTAL NO.	02
TOTAL NET:	+ 5.500 kg



KPZ 2-11-3 



KPZ 2-02-4 





KPZ 2-03-10  IP 65



KPZ 2-04-7 



KPZ 2E-06S  



KPZ 2114



KPZ 2082 Dual counting System



KPZ 1  



KPZ 1 B 



KPZ 2B 



KPZ 2S 



KPZ 2ECO 



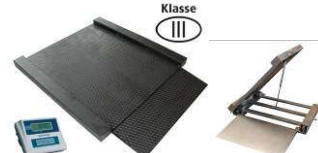

Drive through Scale



KPZ 2D  



KPZ 71-*  

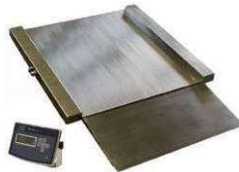

Stainless Steel DIN 1.4301, extrem solid and stable construction, IP 67, 68 and 69K



KPZ 72  



KPZ 73B



KPZ 73SDJ



KPZ 73 



KPZ 74 



KPZ 70 weighing forks



KPZ 39
 Hydraulic Forklift scale



Crane scale 



Coil Scale



Animal scale 



Silo weighing





KPZ PC Software



Special models are our speciality!

Mobile KPZ scales



KPZ 71-7   
Many Option possible



Option KPZ 71-7



KPZ 71-8 
2.200kg / 200g



KPZ 71-9
2.200kg / 500g

KPZ 72



KPZ 72, 2400mm, 3200kg



KPZ 73 



KPZ 73 SDJ 



KPZ 73 B 



KPZ 74 



Weighing forks Forklift truck scale



KPZ 39
Electronic – Hydraulic version



Touch sreen Indicator 7-Zoll



Scale for Coil's



German design and own EU production guarantees high quality.

Stainless steel Material : DIN 1.4301 / 1.4541 / 1.4404

KPZ-Waagen, Stainless steel scale and Indicator, IP 67/68/69K



Platform Scale KPZ 2N, Stainless steel, IP 67/68/69 K

Stainless steel Material : DIN 1.4301 / 1.4541 / 1.4404

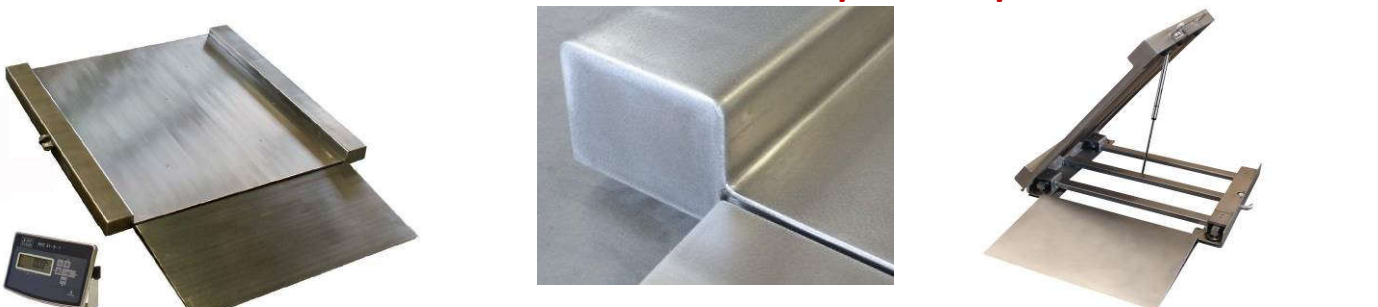

Low construction scale KPZ 2DN

Plain, top plate of platform made of one piece. IP 67/68/69K

Stainless steel Material : DIN 1.4301 / 1.4541 / 1.4404



**Pallet weigher Type: KPZ 71-7N
 stainless steel DIN 1.430, IP 67/68/69K**

**Pallet scale KPZ 1N, IP 67/68/69K
 Stainless steel - Material 1.4301**



**Bench Scale KPZ 2E-06, stainless steel DIN 1.430, IP 67/68, IP 69K
 German design and own EU production guarantees high quality.**

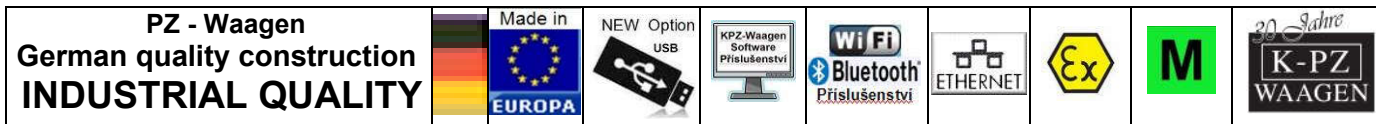

200305 00 N UK €



KPZ - Váhy, s. r. o.

Libošovice 76,
CZ 507 44 Libošovice

Tel.:

+420 736 622 710

+48 661 033 820

+420 493 571 111

email: / zander@kpzwaagen.de / kpz@kpz-vahy.cz

www.kpzwaagen.com